



Model 443B102
Dual Mode Modular Signal Conditioner Card
Installation and Operating Manual

**For assistance with the operation of this product,
contact PCB Piezotronics, Inc.**

Toll-free: 800-828-8840
24-hour SensorLine: 716-684-0001
Fax: 716-684-0987
E-mail: info@pcb.com
Web: www.pcb.com



Repair and Maintenance

PCB guarantees Total Customer Satisfaction through its “Lifetime Warranty Plus” on all Platinum Stock Products sold by PCB and through its limited warranties on all other PCB Stock, Standard and Special products. Due to the sophisticated nature of our sensors and associated instrumentation, **field servicing and repair is not recommended and, if attempted, will void the factory warranty.**

Beyond routine calibration and battery replacements where applicable, our products require no user maintenance. Clean electrical connectors, housings, and mounting surfaces with solutions and techniques that will not harm the material of construction. Observe caution when using liquids near devices that are not hermetically sealed. Such devices should only be wiped with a dampened cloth—never saturated or submerged.

In the event that equipment becomes damaged or ceases to operate, our Application Engineers are here to support your troubleshooting efforts 24 hours a day, 7 days a week. Call or email with model and serial number as well as a brief description of the problem.

Calibration

Routine calibration of sensors and associated instrumentation is necessary to maintain measurement accuracy. We recommend calibrating on an annual basis, after exposure to any extreme environmental influence, or prior to any critical test.

PCB Piezotronics is an ISO-9001 certified company whose calibration services are accredited by A2LA to ISO/IEC 17025, with full traceability to SI through N.I.S.T. In addition to our standard calibration services, we also offer specialized tests, including: sensitivity at elevated or cryogenic temperatures, phase response, extended high or low frequency response, extended range, leak testing, hydrostatic pressure testing, and others. For more information, contact your local PCB Piezotronics distributor, sales representative, or factory customer service representative.

Returning Equipment

If factory repair is required, our representatives will provide you with a Return Material Authorization (RMA) number, which we use to reference any information you have already provided and expedite the repair process. This number should be clearly marked on the outside of all returned package(s) and on any packing list(s) accompanying the shipment.

Contact Information

PCB Piezotronics, Inc.
3425 Walden Ave.
Depew, NY14043 USA
Toll-free: (800) 828-8840
24-hour SensorLine: (716) 684-0001
General inquiries: info@pcb.com
Repair inquiries: rma@pcb.com

For a complete list of distributors, global offices and sales representatives, visit our website, www.pcb.com.

Safety Considerations

This product is intended for use by qualified personnel who recognize shock hazards and are familiar with the precautions required to avoid injury. While our equipment is designed with user safety in mind, the protection provided by the equipment may be impaired if equipment is used in a manner not specified by this manual.

Discontinue use and contact our 24-Hour Sensorline if:

- Assistance is needed to safely operate equipment
- Damage is visible or suspected
- Equipment fails or malfunctions

For complete equipment ratings, refer to the enclosed specification sheet for your product.

Definition of Terms and Symbols

The following symbols may be used in this manual:



DANGER

Indicates an immediate hazardous situation, which, if not avoided, may result in death or serious injury.

**CAUTION**

Refers to hazards that could damage the instrument.

**NOTE**

Indicates tips, recommendations and important information. The notes simplify processes and contain additional information on particular operating steps.

The following symbols may be found on the equipment described in this manual:



This symbol on the unit indicates that high voltage may be present. Use standard safety precautions to avoid personal contact with this voltage.



This symbol on the unit indicates that the user should refer to the operating instructions located in the manual.



This symbol indicates safety, earth ground.



PCB工业监视和测量设备 - 中国RoHS2公布表

PCB Industrial Monitoring and Measuring Equipment - China RoHS 2 Disclosure Table

部件名称	有害物质					
	铅 (Pb)	汞 (Hg)	镉 (Cd)	六价铬 (Cr(VI))	多溴联苯 (PBB)	多溴二苯醚 (PBDE)
住房	0	0	0	0	0	0
PCB板	X	0	0	0	0	0
电气连接器	0	0	0	0	0	0
压电晶体	X	0	0	0	0	0
环氧	0	0	0	0	0	0
铁氟龙	0	0	0	0	0	0
电子	0	0	0	0	0	0
厚膜基板	0	0	X	0	0	0
电线	0	0	0	0	0	0
电缆	X	0	0	0	0	0
塑料	0	0	0	0	0	0
焊接	X	0	0	0	0	0
铜合金/黄铜	X	0	0	0	0	0
本表格依据 SJ/T 11364 的规定编制。						
0：表示该有害物质在该部件所有均质材料中的含量均在 GB/T 26572 规定的限量要求以下。						
X：表示该有害物质至少在该部件的某一均质材料中的含量超出 GB/T 26572 规定的限量要求。						
铅是欧洲RoHS指令2011/65/ EU附件三和附件四目前由于允许的豁免。						

CHINA RoHS COMPLIANCE

Component Name	Hazardous Substances					
	Lead (Pb)	Mercury (Hg)	Cadmium (Cd)	Chromium VI Compounds (Cr(VI))	Polybrominated Biphenyls (PBB)	Polybrominated Diphenyl Ethers (PBDE)
Housing	O	O	O	O	O	O
PCB Board	X	O	O	O	O	O
Electrical Connectors	O	O	O	O	O	O
Piezoelectric Crystals	X	O	O	O	O	O
Epoxy	O	O	O	O	O	O
Teflon	O	O	O	O	O	O
Electronics	O	O	O	O	O	O
Thick Film Substrate	O	O	X	O	O	O
Wires	O	O	O	O	O	O
Cables	X	O	O	O	O	O
Plastic	O	O	O	O	O	O
Solder	X	O	O	O	O	O
Copper Alloy/Brass	X	O	O	O	O	O

This table is prepared in accordance with the provisions of SJ/T 11364.

O: Indicates that said hazardous substance contained in all of the homogeneous materials for this part is below the limit requirement of GB/T 26572.

X: Indicates that said hazardous substance contained in at least one of the homogeneous materials for this part is above the limit requirement of GB/T 26572.

Lead is present due to allowed exemption in Annex III or Annex IV of the European RoHS Directive 2011/65/EU.



BEFORE OPERATING	2
ELECTROSTATIC DISCHARGE.....	2
EQUIPMENT RATINGS	2
GROUNDING	2
EQUIPMENT OVERVIEW.....	2
COMPONENTS AND FEATURES	2
INPUT	2
LOW PASS FILTERS	3
INTEGRATOR AMPLIFIERS	3
OUTPUT AMPLIFIER	3
OVERLOAD DETECTOR	3
REFERENCE OSCILLATOR	3
OPERATION	3
SET-UP AND MEASUREMENT	3
SETTING THE OPERATIONAL MODE.....	3
SETTING THE SENSOR SENSITIVITY	3
SETTING THE OUTPUT SENSITIVITY	4
SETTING THE TIME CONSTANT	4
ZEROING THE OUTPUT IN LONG TIME CONSTANT MODE (443B102 ONLY)	5
SETTING THE LOW PASS FILTER	5
TEDS FEATURES.....	5
VELOCITY MEASUREMENT	5
DISPLACEMENT MEASUREMENT	6
USING THE SETUP MEMORY	6
SETTING THE LCD BACKLIGHT LEVEL.....	6
COMPUTER / RS-232 CONTROL	6
APPENDIX A: RS-232 CONTROL	7
COMMAND SET.....	9
APPENDIX B: FIGURES.....	43



Before Operating

Electrostatic Discharge



High voltage electrostatic discharge (ESD) can damage electrical devices.

To avoid triboelectric transfer:

1. Connect cables only with the AC power off.
2. Temporarily “short” the end of the cable before attaching it to any signal input or output.

Additionally, internal adjustments should be done ONLY in an ESD-safe work area. Even ESD-protected electronics can be vulnerable to extremely high voltage.

Equipment Ratings

This equipment operates at 104°F (40°C), in an environment having 93% relative humidity. Its frequency range is 50/60 Hz. Operation of this unit is limited to environments having an altitude of less than 2 000 meters. The pollution degree for operation of the Model 440 is two (2), meaning that normally, only non-conductive pollution occurs.

The overvoltage category is II, indicating the transient voltage levels that may be tolerated by the equipment.

For complete specifications, refer to the enclosed specification sheet.

Grounding

Indiscriminate grounding of instruments can introduce ground loop interference. To prevent this, it is necessary to ensure that the signal ground lines of the 443B and any other instruments with which it is used are grounded at one point only in the measurement system.

Connect the signal ground lines of all the instruments together. This is done through the shields of the input and the output cables used to interconnect the instruments.

If an instrument with a mains socket chassis terminal is used in the measurement system, check that a) only one of the instruments has its signal ground connected via the chassis to mains ground, and b)

the housing of the transducer is isolated from grounded measurement sources.

If the measurement set-up is mounted in a metal instrumentation rack, ensure that only one of the instruments has its signal ground connected to the chassis (and chassis connected to mains ground if the unit has a mains socket chassis terminal).

Equipment Overview

The Model 443B Dual-Mode Amplifier is a comprehensively equipped charge and ICP® preamplifier intended for use with piezoelectric pressure, force and vibration sensors. This amplifier is particularly useful for field and laboratory measurement of acceleration, velocity, and displacement vibration.

Designed to fit into the PCB Modular Signal Conditioning System, the Model 443B may be used as a single-channel stand-alone system or as part of a four-channel package housed in a single cabinet. It may be controlled remotely via an RS-232 interface when used with a 441 Series chassis with computer control.

ICP® accelerometers with TEDS electronics can be auto-normalized using the Auto TEDS feature. Full TEDS data may be read from the TEDS menu, or through the RS-232 port. Additionally, sensor sensitivity can be digitally selected, and the amplifier can store up to five setups for easy recall.

The unit has unified output ratings, built-in integrators for velocity and displacement, switchable low and high pass filters, and a built-in reference signal. The output is routed to portable Sony DAT Recorders, scopes, and frequency analyzers. In addition, the Model 443B102 offers medium and long time constant settings.

See Figure 3 in Appendix B for Block Diagram.

Components and Features

Input

The input signal is fed to the amplifier via the input connector on the front panel. When sensors with



high temperature transient sensitivity are used, the high pass filter of the amplifier can be changed from 0.2 Hz to 2 Hz, reducing the influence from temperature-induced signals. The overall gain of the amplifier is the ratio of the output sensitivity to the sensor sensitivity.

Low Pass Filters

Six selectable upper cutoff frequencies are provided by the low pass filter, located just after the input amplifier to filter out unwanted signal components before further amplification. The filters are of the two-pole configuration, giving a 12 dB/octave cutoff. The low pass filter section may be turned off giving a frequency response of >200 kHz.

Integrator Amplifiers

The integrator amplifiers provide single integration for velocity and double integration for displacement. Two low-frequency cutoff settings of 1 or 10 Hz are provided in the velocity and displacement modes to suppress low-frequency noise.

Output Amplifier

The output amplifier provides the signal to the continuous gain stage and then to the BNC output connector on the front panel. It provides a fixed gain of x1 or x10.

Typical frequency response as a function of capacitive load of the output of the 443B dual mode amplifier is shown in Figure 7 of Appendix B. Note that for a frequency range up to 10kHz, a capacitive load of up to 50 nF may be applied. For standard cable with a shunt capacitance of 100pF/m, up to 500 m of output cable can be used to cover this frequency range.

Overload Detector

The overload detector monitors the output of the charge amplifier, the low pass filter, and the output, so overload in various parts of the circuitry are not masked by filtering. The overload indicator is located on the front panel. In ICP® mode, the sensor output is also monitored for overloads.

Reference Oscillator

The Model 443B has a built-in reference signal source, providing a signal of 100 pC RMS at 159.2 Hz in charge mode. In ICP® mode, the reference signal is 1 V RMS. These signals can be used as a reference when using portable DAT recorders.

Operation

Set-Up and Measurement

1. Connect the Model 443B to a suitable power source. Switch the unit on and let it stabilize for 30 seconds.
2. Connect the output of the 443B to a suitable indicating instrument, voltmeter, scope or frequency analyzer.
3. Select a suitable accelerometer to be used for the measurement and observe the correct mounting and installation instructions. Connect it to the input connector of the Model 443B.
4. Refer to the accelerometer's calibration chart to select the sensitivity.

Setting the Operational Mode

1. Press the MENU button on the Model 443B. The main menu appears on the screen of the Model 443B.
2. Select the MODE position with the down button.
3. Press the MENU button again. The display now shows the following text:

Charge	Ref. On
ICP	Ref. Off

4. Select the mode by moving the cursor to Charge or ICP® depending upon which type of sensor is being used. Note that in ICP® mode, zero current can be selected, which will put the unit in voltage mode.
5. The internal sinusoidal reference may be turned on by moving the cursor to Ref. On and pressing the MENU button. To turn off the reference, move the cursor to Ref. Off in the MODE menu and press MENU.

Setting the Sensor Sensitivity

1. Press the MENU button again and select SEN



- by pressing the right-facing arrow.
- Press the MENU button again and the cursor is now in the sensor sensitivity position.
 - Enter the sensitivity for the selected accelerometer using the keys with up and down arrows. Note that if the up or down key is held, the display will increment or decrement continuously.
 - Press the MENU key again and the selected charge sensitivity now shows on the Model 443B's display.

Setting the Output Sensitivity

- Press the MENU button. Move the cursor to OUT.
- Press the MENU button again and the cursor is at the output position. Set the output to the desired setting.
- Press the MENU button again and the desired output setting shows on the Model 443B.

Setting the Time Constant

- Press the MENU button again and select the LF position.
- Press the MENU button again, and the display shows:

0.2 Hz 2.0 Hz.
Low Freq. Sel.

Select the suitable lower-limiting frequency of 2 Hz for sensors with high temperature transient sensitivity.

- The Model 443B102 includes medium and long TC options as well. To access them, press the down key again. The display shows:

Med TC Long TC
Low Freq. Sel

- Press the MENU button again after selecting the desired setting. For 0.2Hz, 2Hz and med TC the Model 443B now indicates the selected setting. Verify the setting by the indication on the front panel.
- If long time constant is selected in charge mode (443B102 only), the display will briefly indicate:

Time Constant is >10,000 sec

or:

Time Constant is >100,000 sec

depending on the gain selected. And then:

Autozero in Progress

The autozero function zeros the output to within ± 50 mV of ground.

- The next display will be:

Null Drift?

Yes

No

The 443B102 has a built-in automated drift nulling routine which ensures that the drift is well within the stated specification. This should be run after the unit has been on for at least one hour in long TC mode to allow for proper warm up time. Selecting "Yes" begins the routine. The internal microprocessor will then begin adjusting the leakage current so that the drift is minimized. The process may take up to about 10 minutes, depending on how much adjustment is necessary.



It is recommended that the sensor be disconnected during nulling so that the input is not disturbed.

During nulling, the display will show:

Nulling Drift
Comp Lvl = X.XXX

Where X.XXX is the voltage used internally to adjust the drift. It may range between ± 5 v. If it is necessary to terminate nulling before it is complete, press the MENU key and the unit will return to normal operation. Once the nulling has been completed, the LCD will return to the operating display.

- If the microprocessor is unable to satisfactorily null the drift, the LCD will display:

Unable to Null
Try Again Exit

Selecting "Try Again" will begin the nulling routine, while "Exit" will return the unit to normal operation. Common reasons for failing to null are insufficient warm up time, or leaving the sensor connected to the input.



- Long TC may be selected in ICP® mode, so that the amplifier is DC coupled. When long TC is selected, the LCD will display:

Adjust DC Offset
X.XXXX V

The up and down keys may then be used to adjust the offset so that the sensor bias is removed from the signal.

Zeroing the Output in Long Time Constant Mode (443B102 only)

- To zero the output after making a long time constant measurement, simply push the ZERO key. Alternatively, a two-conductor cable with an SMB connector may be plugged into the EXT ZERO receptacle on the front panel. When the center conductor is shorted to the shell, the ZERO will be actuated.
- ZERO may be locked in long time constant mode by holding down the ZERO key for several seconds. The display will then read:

ZERO LOCKED ON
Push ZERO to Res

This will hold the output at about zero volts, regardless of the charge input. It is recommended to lock the zero on when connecting or disconnecting a sensor, or whenever there is a possibility of overloading the amplifier.

- To release the zero lock, simply push the ZERO key again.

Setting the Low Pass Filter

- Press the MENU button.
- Select LPF using the down and right arrow keys.
- Press the MENU button again. The 443B now shows the following:

0.1k 1k 3k
10k 30k 100k Off

Using the up/down and right/left arrow keys, select the desired low-pass frequency setting.

- Press the MENU button a final time to verify the correct LPF setting on the front panel.

TEDS Features

The 443B incorporates several features which allow the use of sensors with TEDS electronics. The 443B can read the raw data from any TEDS sensor, and is able to locally decode the data from sensors using IEEE 1451.4, UTID 1, and UTID 116225. Raw data in hex form is also available via the RS-232 interface which may then be decoded by the host computer. The RS-232 commands are described in Appendix A.

The easiest way to take advantage of TEDS sensors is the use the auto normalization feature. This feature automatically reads the data in a TEDS sensor when it is connected to the 443B and sets the sensitivity to the value stored in the sensor. Thus the user is spared the inconvenience (and potential error) of locating the sensor's data sheet and manually entering this information. The auto-normalize feature is normally disabled, but may be enabled if desired by selecting TEDS from the main menu and then selecting OFF when the Auto TEDS Read menu is displayed.



The Auto Teds feature can cause erratic output when used with certain sensors. To avoid this possibility, Auto TEDS should be disabled for sensors that have time constants of 1 second or longer, or sensors with high sensitivities (1 V/g and up) .

The remainder of the TEDS data may be viewed by selecting TEDS from the main menu, and continuing through the Auto TEDS Read On/Off menu. The next display will read:

SELECT UNITS
SI ENGLISH

This selection determines whether the TEDS data is displayed in SI or English units. Once this selection has been made, all stored data may be viewed by pushing the down key to scroll through it.

Velocity Measurement

- Press MENU button. The main menu appears on the display:



OUT SEN TED MEM
MODE LF LPF LCD

- Using down and right arrow keys, select LF.
- Press the MENU button.
- Press the down arrow key until the display shows:

1.0 Hz 10.0 Hz
Velocity

- Select the desired setting and press the MENU button. The display shows:

SELECT UNITS
SI ENGLISH

If SI is selected, then SI units are displayed.

Select the desired unit and press MENU. If ENGLISH is selected, the display shows:

XX.XX mV/in/s
X.XXX pC/g

Displacement Measurement

- Press the MENU button. The display shows:

OUT SEN TED MEM
MODE LF LPF LCD

- Select LF and press the menu button. The display shows the previous setting.
- Press the up arrow key until the display shows:

1 Hz 10.0 Hz
Displacement

- Select the appropriate lower frequency and press the MENU button. The display shows:

SELECT UNITS
SI ENGLISH

- Select the desired units and press the MENU button. If ENGLISH was selected the display shows:

X.XXX mV/mil
X.XXX pC/g

If SI is selected, SI units are displayed.

- Set the desired output sensitivity and press the MENU button. The Model 443B is now set up and calibrated for displacement measurements.

Using the Setup Memory

The 443B has the capability to save and recall up to five different setups so that the user can easily switch between frequently used configurations. To save a setup:

- Press MENU and move the cursor to the MEM position.
- Press MENU again.
- Move the cursor to SAVE and press MENU.
- Move the cursor to the number (1-5) of the setup location you wish to save the current configuration in.
- If you decide not to save the setup, move the cursor to CANCEL.
- Press MENU again and the unit will then return to its previous state.
- To recall a setup, first press MENU and move the cursor to the MEM position.
- Press MENU again.
- Move the cursor to RECALL and press MENU.
- Move the cursor to the number of the setup location you wish to recall.
- If you decide not to recall the setup, move the cursor to CANCEL.
- Press MENU again and the unit will reset itself to the stored configuration.

Setting the LCD Backlight Level

- Press MENU and select LCD.
- Press MENU and the display shows:

LCD BACKLIGHTING
3 2 1 Off

- Select the desired backlight level and press MENU.

Computer / RS-232 Control

The 443B series provides for remote control of all functions via an RS-232 interface when used with a model 441A3X chassis with computer control. Appendix A gives the setup information as well as the command set.



Appendix A: RS-232 Control

For RS-232 communication, the port settings should be as follows:

General	RS-232, DCE interface, XON/XOFF flow control, Asynchronous protocol
Baud Rate	9600 Baud
Start Bits	1
Data Bits	8
Parity	None
Stop Bits	1

The message format is as follows:

Start Byte (0x02)	Destination ID (Rack/Slot)	Command	End Byte (0x03)	Checksum
-------------------	----------------------------	---------	-----------------	----------

Start Byte	STX (0x02) - marks the start of a new message.
Destination ID	16 bits - rack code (0-3 ASCII) followed by slot address (0-9 ASCII). Messages meant for the master will have "MM" in this field.
Command	Contains the command followed by any associated data. See below for command structure, and command set for examples.
End Byte	ETX (0x03) - marks the end of the message.
Data Checksum	16 bits - the ASCII hex of the 8-bit sum, ignoring overflows, of all bytes in the message including SOT and ETX bytes.

All messages sent to the rack will receive a response. A typical command transaction is shown below.

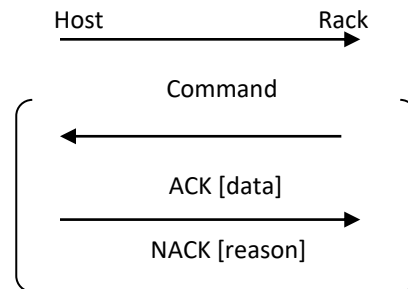

The ACK/NAK field conveys information concerning the delivery of messages. The results of command operations are contained in the data field of an ACK message. NAK reason bytes are defined below.

Start Byte (0x02)	ACK (0x06)	Data Field	End Byte (0x03)	Checksum
-------------------	------------	------------	-----------------	----------

The Format of an ACK Message



Start Byte (0x02)	NAK (0x15)	Reason Byte	End Byte (0x030)	Checksum
-------------------	------------	-------------	------------------	----------

The Format of a NAK Message

Reason Byte	Description
'C'	Check sum error in message received from external host.
'D'	Data overflow error – the size of the data field was larger than the message buffer. The buffer is 95 bytes long.
'F'	A framing error occurred – ETX was received before it was expected.
'I'	Check sum error occurred while communicating with internal module.
'T'	Time-out – message not sent, rack/slot address may be incorrect.

NAK Reason Bytes

Command format is shown below:

Module Type	Module Command	Data Field
-------------	----------------	------------

Module Type	Three ASCII printable characters. This field identifies the type of module the command is meant for. For the 443B series, this will be either C01 (for 443B101) or C02 (for 443B102).
Module Command	Four printable ASCII characters. This field identifies the command for the module.
Data Field	Contains any data associated with the command.



Command Set

This list of commands is the currently supported set that is applicable to the 443B101 and 443B102 Dual Mode Amplifier modules.

Command: MMOD

Purpose:	This command returns the module type of the card at the location specified by the command.
Response:	The response string is 3 ASCII printable characters that correspond to the module type of the module at the location specified by the command.
Command Attribute:	This command is supported by all modules using the protocol defined for the 441 series racks (it is a common or "CMM" command).
Command String:	XYCMMMMOD
Description:	X—Rack number of the target module (Range: ASCII printable characters, 0 through 3) Y— Slot number of the target module. (Range: ASCII printable characters, 0 through 7) CMM—Module type for the target. Specifying "CMM" in this argument indicates the intention of any module type that may be found in Rack X, Slot Y. (Range: 3 ASCII printable characters) MMOD—Commands target module to return its 3 character module type.
Response String:	"C01" for 443B101 and "C02" for 443B102
Description:	These 3 ASCII printable characters are the module type of the module at the location specified by the command.
Example:	Command String: "02CMMMMOD" Response String: "C02" The module type of the card in rack 0 and slot 2 is a C02 (443B102).



Command: SVER

Purpose:	This command returns the software version number of the firmware in the target module.
Response:	The response string is 5 ASCII printable characters that correspond to the software version number of the module at the location specified by the command.
Command Attribute:	This command is supported by all modules using the protocol defined for the 441 series racks (it is a common or "CMM" command).
Command String:	XYCMMSVER
	<p>Description: X—Rack number of the target module (Range: ASCII printable characters, 0 through 3) Y— Slot number of the target module. (Range: ASCII printable characters, 0 through 7) CMM—Module type for the target. Specifying "CMM" in this argument indicates the intention of any module type that may be found in Rack X, Slot Y. (Range: 3 ASCII printable characters) SVER—Commands the target module to return its 5 character software version number.</p>
Response String:	XX.XX
Description:	The first 2 ASCII printable characters are the major revision of the firmware. The next ASCII printable character is a '.' and is used as a placeholder for the major and minor revisions of the firmware. The next 2 ASCII printable characters are the minor revision of the firmware.
Example:	<p>Command String: "04CMMSVER" Response String: "03.00"</p> <p>The software version number of the card in rack 0 and slot 4 is 3.00.</p>



Command: SER#

Purpose:	Returns the serial number of the card at the target location.
Response:	The response string is 6 ASCII printable characters that correspond to the serial number of the module at the location sent by the command.
Command String:	XYCMMSER#
Description:	<p>X—Rack number of the target module (Range: ASCII printable characters, 0 through 3)</p> <p>Y— Slot number of the target module. (Range: ASCII printable characters, 0 through 7)</p> <p>CMM—Module type for the target. Specifying "CMM" in this argument indicates the intention of any module type that may be found in Rack X, Slot Y. (Range: 3 ASCII printable characters)</p> <p>SER#— Commands target module to return its 6 character serial number.</p>
Response String:	ZZZZZZ
Description:	These 6 ASCII printable characters are the serial number of the module at the location sent by the command.
Example:	<p>Command String: "00CMMSER#"</p> <p>Response String: "000204"</p> <p>The serial number of the card in rack 0 and slot 0 is 000204.</p>



Command: OUTS

Purpose:	Sets the output sensitivity of the amplifier.
Response:	The module responds with a "0" to tell the calling process the command has been received.
Command String:	XYCOZOUTSXX.XX
Description:	<p>X— Rack number of the target module (Range: ASCII printable characters, 0 through 3)</p> <p>Y— Slot number of the target module. (Range: ASCII printable characters, 0 through 7)</p> <p>C0Z— Module type for the target. Specifying "C01" in this argument addresses a 443B101, specifying "C02" addresses a 443B102. (Range: 3 ASCII printable characters)</p> <p>OUTS— Commands the module to set the output sensitivity</p> <p>XX.XX— 5 character output sensitivity. (Range: ASCII printable characters, 0 through 9)</p>
Response String:	"0"
Description:	This return indicates that the command was received by the card.
Example:	<p>Command String: "02C02OUTS1.001"</p> <p>Response String: "0"</p> <p>The output sensitivity of the 443B102 in rack 0, and slot 2 will be set to 1.001.</p>



Command: XDCR

Purpose:	Sets the transducer sensitivity of the amplifier.
Response:	The module responds with a "0" to tell the calling process the command has been received.
Command String:	XYCOZXDCRXX.XX
Description:	<p>X— Rack number of the target module (Range: ASCII printable characters, 0 through 3)</p> <p>Y— Slot number of the target module. (Range: ASCII printable characters, 0 through 7)</p> <p>C0Z— Module type for the target. Specifying "C01" in this argument addresses a 443B101, specifying "C02" addresses a 443B102.</p> <p>XDCR— Commands the module to set the output sensitivity</p> <p>XX.XX— 5 character transducer sensitivity. (Range: ASCII printable characters, 0 through 9)</p>
Response String:	"0"
Description:	This return indicates that the command was received by the card.
Example:	<p>Command String: "04C01XDCR2.034"</p> <p>Response String: "0"</p> <p>The output sensitivity of the 443B101 in rack 0, and slot 4 will be set to 2.034.</p>



Command: CHRG

Purpose:	Puts the amplifier into charge mode.	
Response:	The module responds with a "0" to tell the calling process the command has been received.	
Command String:	XYCOZCHRG	
Description:	<p>X—Rack number of the target module (Range: ASCII printable characters, 0 through 3)</p> <p>Y— Slot number of the target module. (Range: ASCII printable characters, 0 through 7)</p> <p>C0Z— Module type for the target. Specifying "C01" in this argument addresses a 443B101, specifying "C02" addresses a 443B102.</p> <p>CHRG— Commands module to charge mode.</p>	
Response String:	"0"	
Description:	This return indicates that the command was received by the card.	
Example:	Command String:	"00C01CHRG"
	Response String:	"0"
	The 443B101 in rack 0 and slot 0 is set to charge mode.	



Command: ICPM

Purpose:	Puts the amplifier into ICP mode and sets the constant current.	
Response:	The module responds with a "0" to tell the calling process the command has been received.	
Command String:	XYCOZICPMZZ	
Description:	<p>X—Rack number of the target module (Range: ASCII printable characters, 0 through 3) Y— Slot number of the target module. (Range: ASCII printable characters, 0 through 7)</p> <p>C0Z— Module type for the target. Specifying "C01" in this argument addresses a 443B101, specifying "C02" addresses a 443B102.</p> <p>ICPM— Commands module to charge mode.</p> <p>ZZ— specifies the constant current as follows:</p> <p>"00" turns the constant current off (voltage mode). "02" sets the constant current to 2 mA. "04" sets the constant current to 4 mA. "08" sets the constant current to 8 mA. "12" sets the constant current to 12 mA. "20" sets the constant current to 20 mA.</p>	
Response String:	"0"	
Description:	This return indicates that the command was received by the card.	
Example:	Command String:	"06C02ICPM08"
	Response String:	"0"
	The 443B102 in rack 0 and slot 6 is set to ICP mode and the constant current is 8 mA.	



Command: SETF

Purpose:	Sets the cutoff frequency of the low pass filter.
Response:	The module responds with a "0" to tell the calling process the command has been received.
Command String:	XYCOZSETFZ
Description:	<p>X—Rack number of the target module (Range: ASCII printable characters, 0 through 3)</p> <p>Y— Slot number of the target module. (Range: ASCII printable characters, 0 through 7)</p> <p>C0Z— Module type for the target. Specifying "C01" in this argument addresses a 443B101, specifying "C02" addresses a 443B102.</p> <p>SETF— Commands module to change the low pass filter setting.</p> <p>Z— specifies the low pass filter setting as follows:</p> <p>"0" turns the low pass filter off.</p> <p>"1" sets the low pass filter to the 100 Hz cutoff.</p> <p>"2" sets the low pass filter to the 1kHz cutoff.</p> <p>"3" sets the low pass filter to the 3 kHz cutoff.</p> <p>"4" sets the low pass filter to the 10 kHz cutoff.</p> <p>"5" sets the low pass filter to the 30 kHz cutoff.</p> <p>"6" sets the low pass filter to the 100 kHz cutoff.</p>
Response String:	"0"
Description:	This return indicates that the command was received by the card.
Example:	<p>Command String: "06C02SETF3"</p> <p>Response String: "0"</p> <p>The low pass filter of the 443B102 in rack 0 and slot 6 is set to the 3 kHz cutoff frequency.</p>



Command: LOWF

Purpose:	Sets the low frequency response of the amplifier.
Response:	The module responds with a "0" to tell the calling process the command has been received.
Command String:	XYC0ZLOWFZ
Description:	<p>X—Rack number of the target module (Range: ASCII printable characters, 0 through 3)</p> <p>Y— Slot number of the target module. (Range: ASCII printable characters, 0 through 7)</p> <p>C0Z— Module type for the target. Specifying "C01" in this argument addresses a 443B101, specifying "C02" addresses a 443B102.</p> <p>LOWF— Commands module to change the low frequency response.</p> <p>Z— specifies the low frequency response as follows:</p> <p>"1" sets the low frequency response to 0.2 Hz.</p> <p>"2" sets the low frequency response to 2.0 Hz</p> <p>"3" engages the medium time constant.</p> <p>"4" engages the long time constant.</p>
Response String:	"0"
Description:	This return indicates that the command was received by the card.
Example:	<p>Command String: "06C02LOWF3"</p> <p>Response String: "0"</p> <p>The 443B102 in rack 0 and slot 6 is set to medium time constant mode.</p>



Command: INTG

Purpose:	Engages the internal integration circuitry.
Response:	The module responds with a "0" to tell the calling process the command has been received.
Command String:	XYCOZINTGZ
Description:	<p>X—Rack number of the target module (Range: ASCII printable characters, 0 through 3)</p> <p>Y— Slot number of the target module. (Range: ASCII printable characters, 0 through 7)</p> <p>C0Z— Module type for the target. Specifying "C01" in this argument addresses a 443B101, specifying "C02" addresses a 443B102.</p> <p>INTG— Commands module to engage integration circuitry.</p> <p>Z— specifies the integrator as follows:</p> <p>"1" engages single integration down to 1 Hz.</p> <p>"2" engages single integration down to 10 Hz.</p> <p>"3" engages double integration down to 1 Hz.</p> <p>"4" engages double integration down to 10 Hz.</p>
Response String:	"0"
Description:	This return indicates that the command was received by the card.
Example:	<p>Command String: "06C02INTG3"</p> <p>Response String: "0"</p> <p>The 443B102 in rack 0 and slot 6 is set to engage double integration circuitry with low frequency response down to 1 Hz.</p>



Command: INTU

Purpose:	Sets the integration units used (SI or English).
Response:	The module responds with a "0" to tell the calling process the command has been received.
Command String:	XYCOZINTUZ
Description:	<p>X—Rack number of the target module (Range: ASCII printable characters, 0 through 3)</p> <p>Y— Slot number of the target module. (Range: ASCII printable characters, 0 through 7)</p> <p>C0Z— Module type for the target. Specifying "C01" in this argument addresses a 443B101, specifying "C02" addresses a 443B102.</p> <p>INTU— Commands module to set the integration units.</p> <p>Z— specifies the integration units as follows:</p> <p>"1" sets integration units to English.</p> <p>"2" sets integration units to SI</p>
Response String:	"0"
Description:	This return indicates that the command was received by the card.
Example:	<p>Command String: "04C01INTU2"</p> <p>Response String: "0"</p> <p>The 443B101 in rack 0 and slot 4 is set use SI units for integration.</p>



Command: REF1

Purpose:	Turns on the internal sinusoidal reference oscillator.	
Response:	The module responds with a "0" to tell the calling process the command has been received.	
Command String:	XYCOZREF1	
Description:	<p>X—Rack number of the target module (Range: ASCII printable characters, 0 through 3)</p> <p>Y— Slot number of the target module. (Range: ASCII printable characters, 0 through 7)</p> <p>C0Z— Module type for the target. Specifying "C01" in this argument addresses a 443B101, specifying "C02" addresses a 443B102.</p> <p>REF1— Commands module to turn on the internal oscillator.</p>	
Response String:	"0"	
Description:	This return indicates that the command was received by the card.	
Example:	Command String:	"04C01REF1"
	Response String:	"0"
	The 443B101 in rack 0 and slot 4 is commanded to turn on the internal oscillator.	



Command: REF0

Purpose:	Turns off the internal sinusoidal reference oscillator.	
Response:	The module responds with a "0" to tell the calling process the command has been received.	
Command String:	XYCOZREF0	
Description:	<p>X—Rack number of the target module (Range: ASCII printable characters, 0 through 3)</p> <p>Y— Slot number of the target module. (Range: ASCII printable characters, 0 through 7)</p> <p>C0Z— Module type for the target. Specifying "C01" in this argument addresses a 443B101, specifying "C02" addresses a 443B102.</p> <p>REF0— Commands module to turn off the internal oscillator.</p>	
Response String:	"0"	
Description:	This return indicates that the command was received by the card.	
Example:	Command String:	"04C01REF0"
	Response String:	"0"
	The 443B101 in rack 0 and slot 4 is commanded to turn off the internal oscillator.	



Command: ZERO

Purpose:	Zeros the output of a 443B102 when in long time constant charge mode.
Response:	The module responds with a "0" to tell the calling process the command has been received.
Command String:	XYC02ZERO
Description:	<p>X—Rack number of the target module (Range: ASCII printable characters, 0 through 3)</p> <p>Y— Slot number of the target module. (Range: ASCII printable characters, 0 through 7)</p> <p>C02— Module type for the target. Only type "C02" (443B102) can accept this command since the 443B101 does not have long time constant.</p> <p>ZERO—Commands the module to reset the charge stage.</p>
Response String:	"0"
Description:	This return indicates that the command was received by the card.
Example:	<p>Command String: "04C02ZERO"</p> <p>Response String: "0"</p> <p>The 443B102 in rack 0 and slot 4 is commanded to zero its output.</p>



Command: ZLCK

Purpose:	Clamps the output of a 443B102 when in long time constant charge mode.
Response:	The module responds with a "0" to tell the calling process the command has been received.
Command String:	XYC02ZLCK
Description:	<p>X—Rack number of the target module (Range: ASCII printable characters, 0 through 3)</p> <p>Y— Slot number of the target module. (Range: ASCII printable characters, 0 through 7)</p> <p>C02— Module type for the target. Only type "C02" (443B102) can accept this command since the 443B101 does not have long time constant.</p> <p>ZLCK—Commands the module to clamp the charge stage. Note: Zero lock is released upon receipt of any other valid command.</p>
Response String:	"0"
Description:	This return indicates that the command was received by the card.
Example:	<p>Command String: "04C02ZLCK"</p> <p>Response String: "0"</p> <p>The 443B102 in rack 0 and slot 4 is commanded to clamp its output.</p>



Command: NULL

Purpose:	Initiates the automated drift nulling routine when in long time constant charge mode.
Response:	The module responds with a "0" to tell the calling process the command has been received.
Command String:	XYC02NULL
Description:	<p>X—Rack number of the target module (Range: ASCII printable characters, 0 through 3)</p> <p>Y— Slot number of the target module. (Range: ASCII printable characters, 0 through 7)</p> <p>C02— Module type for the target. Only type "C02" (443B102) can accept this command since the 443B101 does not have long time constant.</p> <p>NULL—Commands the module to begin drift nulling.</p>
Response String:	<p>"0"</p> <p>Note: Subsequent commands will receive the response "NULLING". The only way to end the nulling routine is to send a "TERM" command.</p>
Description:	This return indicates that the command was received by the card.
Example:	<p>Command String: "04C02NULL"</p> <p>Response String: "0"</p> <p>The 443B102 in rack 0 and slot 4 is commanded to begin nulling drift.</p>



Command: TERM

Purpose:	Terminates the automated drift nulling routine when in long time constant charge mode.
Response:	The module responds with a "0" to tell the calling process the command has been received.
Command String:	XYC02TERM
Description:	<p>X—Rack number of the target module (Range: ASCII printable characters, 0 through 3)</p> <p>Y— Slot number of the target module. (Range: ASCII printable characters, 0 through 7)</p> <p>C02— Module type for the target. Only type "C02" (443B102) can accept this command since the 443B101 does not have long time constant.</p> <p>TERM—Commands the module to terminate drift nulling.</p>
Response String:	"0"
Description:	This return indicates that the command was received by the card.
Example:	<p>Command String: "04C02TERM"</p> <p>Response String: "0"</p> <p>The 443B102 in rack 0 and slot 4 is commanded to terminate the drift nulling routine.</p>



Command: OFFS

Purpose:	Sets the dc offset of the amplifier when in ICP long time time constant mode.
Response:	The module responds with a "0" to tell the calling process the command has been received.
Command String:	XYCO2OFFSXX.XXX
Description:	<p>X— Rack number of the target module (Range: ASCII printable characters, 0 through 3)</p> <p>Y— Slot number of the target module. (Range: ASCII printable characters, 0 through 7)</p> <p>C02— Module type for the target. Only type "C02" (443B102) can accept this command since the 443B101 does not have long time constant.</p> <p>OFFS— Commands the module to set the dc offset.</p> <p>XX.XXX— 6 character offset voltage. (Range: ASCII printable characters, 0 through 9). Only positive offsets are allowed, up to 20.000 volts.</p>
Response String:	"0"
Description:	This return indicates that the command was received by the card.
Example:	<p>Command String: "02C02OFFS10.361"</p> <p>Response String: "0"</p> <p>The dc offset level of the 443B102 in rack 0, and slot 2 will be set to 10.361 volts.</p>



Command: OFF?

Purpose: Returns the dc offset of the amplifier when in ICP long time time constant mode.

Response: The module responds with the 6 character dc offset voltage.

Command String: XYCO2OFF?

Description: X— Rack number of the target module (Range: ASCII printable characters, 0 through 3)
Y— Slot number of the target module. (Range: ASCII printable characters, 0 through 7)

C02— Module type for the target. Only type "C02" (443B102) can accept this command since the 443B101 does not have long time constant.

OFF?— Commands the module to return the dc offset.

Response String: XX.XXX

Description: This return indicates that the command was received by the card.

Example: Command String: "02C02OFF?"
Response String: "10.361"

The dc offset level of the 443B102 in rack 0, and slot 2 is set to 10.361 volts.



Command: STAT

Purpose:	Returns the settings of the 443B.	
Response:	The module responds with a string of the various settings delimited with semicolons.	
Command String:	XYCOZSTAT	
Description:	<p>X— Rack number of the target module (Range: ASCII printable characters, 0 through 3)</p> <p>Y— Slot number of the target module. (Range: ASCII printable characters, 0 through 7)</p> <p>C0Z— Module type for the target. Specifying "C01" in this argument addresses a 443B101, specifying "C02" addresses a 443B102.</p> <p>STAT— Commands the module to return its settings.</p>	
Response String:	See next page.	
Example:	See end of response string definitions for example.	
Response String:	Mode; Output Sensitivity; Transducer Sensitivity; Low Frequency Response; Low Pass Filter; Integration Units; Reference; Overvoltage; Fault (ICP mode only); Zero Lock (long time constant charge mode only)	
Description:	<p>Mode</p> <p>ICP 0mA</p> <p>ICP 2mA</p> <p>ICP 4mA</p> <p>ICP 8mA</p> <p>ICP 12mA</p> <p>ICP 20mA</p>	<p>CHRG</p> <p>Charge mode.</p> <p>ICP mode with 0mA constant current (voltage mode).</p> <p>ICP mode with 2mA constant current.</p> <p>ICP mode with 4mA constant current.</p> <p>ICP mode with 8mA constant current.</p> <p>ICP mode with 12mA constant current.</p> <p>ICP mode with 20mA constant current.</p>
Output Sensitivity	<p>XX.XX mV/unit</p> <p>XX.XX mV/in/sec</p> <p>XX.XX mV/mil</p> <p>XX.XX mV/m/sec</p> <p>XX.XX mV/mm</p>	<p>Output sensitivity without integration.</p> <p>Output sensitivity with single integration and English units.</p> <p>Output sensitivity with double integration and English units.</p> <p>Output sensitivity with single integration and SI units.</p> <p>Output sensitivity with double integration and SI units.</p>
Transducer Sensitivity	<p>XX.XX pC/unit</p> <p>XX.XX pC/g</p>	<p>Transducer sensitivity for a charge sensor without integration.</p> <p>Transducer sensitivity for a charge sensor</p>



	XX.XX pC/m/s ²	using English units in integration mode. Transducer sensitivity for a charge sensor using SI units in integration mode.
Low Frequency Response	0.2 Hz 2.0 Hz Med TC Long TC S Int 1 Hz S Int 10 Hz D Int 1 Hz D Int 10 Hz	Low frequency response 0.2 Hz. Low frequency response 2.0 Hz. Medium time constant . Long time constant. Single integration to 1 Hz Single integration to 10 Hz Double integration to 1 Hz Double integration to 10 Hz
Low Pass Filter	0.1 kHz 1.0 kHz 3.0 kHz 10 kHz 30 kHz 100 kHz	Low pass filter set to 100 Hz. Low pass filter set to 1.0 kHz. Low pass filter set to 3.0 kHz. Low pass filter set to 10 kHz. Low pass filter set to 30 kHz. Low pass filter set to 100 kHz.
Integration Units	SI Eng	SI units will be used for input and output English units will be used for input and output sensitivities in integration mode.
Reference	Ref On Ref Off	The internal sinusoidal reference is on. The internal sinusoidal reference is off.
Overtoltage	OV=1 OV=0	The 443B is overloaded. The 443B is not overloaded.
Fault (only sent in ICP mode)	Fault=1 Fault=0	There is an open or short at the input. The sensor bias is within the acceptable range.
Zero Lock (only sent in long TC charge mode)	Zero Lock On	The reset is clamped on. Nothing is sent if zero lock is off.
Example:	Command String: Response String:	"02C02STAT" "ICP 2mA;10.00 mV/unit; 1.023 mV/unit;2.0 Hz;10kHz; SI;



Ref Off;OV=1;Fault=0;"

The 443B102 in rack 0, slot 2 is setup as follows: ICP mode with a constant current of 2 mA, output sensitivity is 10.00 mV/unit, transducer sensitivity is 1.023 mV/unit, low frequency response is 2.0 Hz, low pass filter set to 10 kHz, integration units are SI, the internal reference is off, the unit is not overloaded, and there is no fault condition detected.



Command: TEDR

Purpose:	Returns data stored in the TEDS sensor. Note: For sensors programmed with "Accelerometer, transfer function v0.91" (UTID 116225), use MTED in conjunction with TEDR to retrieve all of the stored data.
Response:	The module responds with a string of data delimited with semicolons.
Command String:	XYCOZTEDR
Description:	<p>X— Rack number of the target module (Range: ASCII printable characters, 0 through 3)</p> <p>Y— Slot number of the target module. (Range: ASCII printable characters, 0 through 7)</p> <p>C0Z— Module type for the target. Specifying "C01" in this argument addresses a 443B101, specifying "C02" addresses a 443B102.</p> <p>TEDR— Commands the module to return data from the TEDS sensor.</p>
Response String:	Manufacturer Model Number; Serial Number; Sensitivity; Reference Frequency; Calibration Date; Low Frequency Response; Output Phase; Sensitivity Direction; Measurement ID; User Data;
Example:	<p>Command String: "04C01TEDR"</p> <p>Return String: PCB 333M07; SN 17704; 100.2 mV/g; F ref 99.6; cal'd 3/21/2001; F hp 0.025 Hz; phase 0; sens dir N/A; meas ID 0; test sample 4;</p> <p>The 443B101 in rack 0 and slot 4 is commanded to return the data stored in the TEDS sensor connected to its input.</p>



Command: MTED

Purpose:	Returns more data stored in the TEDS sensor . Note: Sensors programmed with the "Accelerometer, transfer function v0.91" template (UTID 116225) contain more data than can be returned by the TEDR command so MTED must be used also to retrieve all of the stored data.
Response:	The module responds with a string of data delimited with semicolons.
Command String:	XYCOZMTED
Description:	X— Rack number of the target module (Range: ASCII printable characters, 0 through 3) Y— Slot number of the target module. (Range: ASCII printable characters, 0 through 7) C0Z— Module type for the target. Specifying "C01" in this argument addresses a 443B101, specifying "C02" addresses a 443B102. MTED— Commands the module to return more data from the TEDS sensor.
Response String:	Low pass cut-off frequency; Resonance Frequency; Quality factor; Amplitude Slope; Temperature coefficient; Reference temperature;
Example:	Command String: "04C01MTED" Return String: F lp 10011; Fres 100336; Mounted Q 10.8; Amp Slope 1.002; Temp Coeff 0.236; Ref Temp 25.0; The 443B101 in rack 0 and slot 4 is commanded to return more data stored in the TEDS sensor connected to its input.



Command: TEDD

Purpose:	Returns raw hex data stored in the TEDS device.
Response:	The module responds with the CRC followed by a 32 byte string of hex data.
Command String:	XYCOZTEDD
Description:	<p>X— Rack number of the target module (Range: ASCII printable characters, 0 through 3)</p> <p>Y— Slot number of the target module. (Range: ASCII printable characters, 0 through 7)</p> <p>C0Z— Module type for the target. Specifying "C01" in this argument addresses a 443B101, specifying "C02" addresses a 443B102.</p> <p>TEDD— Commands the module to return raw hex data stored in the TEDS device.</p>
Response String:	CRC followed by 32 bytes of hex data.
Example:	<p>Command String: "04C01TEDD"</p> <p>Return String: C917D014D00E942200005C12EC64352D 87010000000000000000000000000000 (where C9 is the CRC byte)</p> <p>The 443B101 in rack 0 and slot 4 is commanded to turn return the raw hex data stored in the TEDS device.</p>



Command: TED1

Purpose:	Enables the auto TEDS normalization feature.
Response:	The module responds with a "0" to tell the calling process the command has been received.
Command String:	XYC0ZTED1
Description:	<p>X—Rack number of the target module (Range: ASCII printable characters, 0 through 3)</p> <p>Y— Slot number of the target module. (Range: ASCII printable characters, 0 through 7)</p> <p>C0Z— Module type for the target. Specifying "C01" in this argument addresses a 443B101, specifying "C02" addresses a 443B102.</p> <p>TED1— enables the auto TEDS normalization feature.</p>
Response String:	"0"
Description:	This return indicates that the command was received by the card.
Example:	<p>Command String: "06C02TED1"</p> <p>Response String: "0"</p> <p>The 443B102 in rack 0 and slot 6 is commanded to enable the auto TEDS normalization feature.</p>



Command: TED0

Purpose:	Disables the auto TEDS normalization feature.	
Response:	The module responds with a "0" to tell the calling process the command has been received.	
Command String:	XYC0ZTED0	
Description:	<p>X—Rack number of the target module (Range: ASCII printable characters, 0 through 3)</p> <p>Y— Slot number of the target module. (Range: ASCII printable characters, 0 through 7)</p> <p>C0Z— Module type for the target. Specifying "C01" in this argument addresses a 443B101, specifying "C02" addresses a 443B102.</p> <p>TED0— disables the auto TEDS normalization feature.</p>	
Response String:	"0"	
Description:	This return indicates that the command was received by the card.	
Example:	Command String:	"06C02TED0"
	Response String:	"0"
	The 443B102 in rack 0 and slot 6 is commanded to disable the auto TEDS normalization feature.	



Command: TEDU

Purpose:	Writes to the user data field of a TEDS sensor (13 characters maximum).
Response:	The module responds with a "0" to tell the calling process the command has been received.
Command String:	XYCOZTEDU
Description:	<p>X—Rack number of the target module (Range: ASCII printable characters, 0 through 3)</p> <p>Y— Slot number of the target module. (Range: ASCII printable characters, 0 through 7)</p> <p>C0Z— Module type for the target. Specifying "C01" in this argument addresses a 443B101, specifying "C02" addresses a 443B102.</p> <p>TEDU— tells the module to write to the user data field of a TEDS sensor.</p>
Response String:	"0"
Description:	This return indicates that the command was received by the card.
Example:	<p>Command String: "06C02TEDU13 Characters"</p> <p>Response String: "0"</p> <p>The 443B102 in rack 0 and slot 6 is commanded to write The string "13 Characters" to the user data field of a TEDS sensor.</p>



Command: TMID

Purpose:	Writes a number (0 to 511) to the measurement position ID field of a TEDS sensor.
Response:	The module responds with a "0" to tell the calling process the command has been received.
Command String:	XYCOZTMID
Description:	<p>X—Rack number of the target module (Range: ASCII printable characters, 0 through 3)</p> <p>Y— Slot number of the target module. (Range: ASCII printable characters, 0 through 7)</p> <p>COZ— Module type for the target. Specifying "C01" in this argument addresses a 443B101, specifying "C02" addresses a 443B102.</p> <p>TMID—tells the module to write to the measurement position ID field of a TEDS sensor.</p>
Response String:	"0"
Description:	This return indicates that the command was received by the card.
Example:	<p>Command String: "06C02TMID132"</p> <p>Response String: "0"</p> <p>The 443B102 in rack 0 and slot 6 is commanded to write the number 132 to the measurement position ID field of the TEDS sensor.</p>



Command: TEDW

Purpose:	Writes 32 bytes of hex data to a TEDS device.
Response:	The module responds with a "0" to tell the calling process the command has been received.
Command String:	XYCOZTEDW
Description:	<p>X—Rack number of the target module (Range: ASCII printable characters, 0 through 3)</p> <p>Y— Slot number of the target module. (Range: ASCII printable characters, 0 through 7)</p> <p>C0Z— Module type for the target. Specifying "C01" in this argument addresses a 443B101, specifying "C02" addresses a 443B102.</p> <p>TEDW— tells the module to write 32 bytes of hex data to a TEDS device.</p>
Response String:	"0"
Description:	This return indicates that the command was received by the card.
Example:	<p>Command String: "06C02TEDWF517D014D08EC321 0000BC11C06F35718B0100202020 20202020202020202020"</p> <p>Response String: "0"</p> <p>The 443B102 in rack 0 and slot 6 is commanded to write 32 bytes of hex data to a TEDS device.</p>



Command: RDAR

Purpose: Reads the 8 bytes in the application register (or application register scratchpad if unlocked) of the TEDS chip (DS2430).

Response: The module responds with an 8 byte string of hex data in ASCII format.

Command String: XYCOZR DAR

Description: X—Rack number of the target module (Range: ASCII printable characters, 0 through 3)
Y— Slot number of the target module. (Range: ASCII printable characters, 0 through 7)

C0Z— Module type for the target. Specifying "C01" in this argument addresses a 443B101, specifying "C02" addresses a 443B102.

RDAR— tells the module to read the 8 bytes in the application register (or application register scratchpad if unlocked) of a TEDS device.

Response String: 8 bytes of hex data in ASCII format.

Example: Command String: "06C02RDAR"
Response String: "AABBCCDDEFFAABB"

The 443B102 in rack 0 and slot 6 is commanded to read 8 bytes of hex data from the application register of a TEDS device. The contents, "AABBCCDDEFFAABB" are returned.

Note: After receiving the RDAR or WRAR command, the 443B will be left in TEDS mode and will not be able to power an ICP[®] sensor. This is because the application register memory is non-volatile when not locked so that whatever was written would be lost if the unit was returned to "analog" mode. This feature allows the host to check the data in the application register before locking it. The 'TOFF' command must be issued to return the unit to analog mode.



Command: WRAR

Purpose:	Writes 8 bytes to the application register scratchpad of the TEDS chip (DS2430).	
Response:	The module responds with a "0" to tell the calling process the command has been received.	
Command String:	XYCOZWRAR	
Description:	<p>X—Rack number of the target module (Range: ASCII printable characters, 0 through 3)</p> <p>Y— Slot number of the target module. (Range: ASCII printable characters, 0 through 7)</p> <p>C0Z— Module type for the target. Specifying "C01" in this argument addresses a 443B101, specifying "C02" addresses a 443B102.</p> <p>WRAR— tells the module to write 8 bytes to the application register of a TEDS device.</p>	
Response String:	"0"	
Example:	Command String:	"06C02WRARAABBCCDDEEFFAABB"
	Response String:	"0"

The 443B102 in rack 0 and slot 6 is commanded to write 8 bytes of hex data ("06C02WRARAABBCCDDEEFFAABB") to the application register of a TEDS device.

Note:

- 1) If the application register is locked, this command will have no effect on its contents. See STAT command description for information regarding how to determine the status of the application register.
- 2) After receiving the RDAR or WRAR command, the 443B will be left in TEDS mode and will not be able to power an ICP[®] sensor. This is because the application register memory is non-volatile when not locked so that whatever was written would be lost if the unit was returned to "analog" mode. This feature allows the host to check the data in the application register before locking it. The 'TOFF' command must be issued to return the unit to analog mode.



Command: RDSR

Purpose:	Reads the Status Register byte which indicates if the application register of the TEDS chip (DS2430) has been locked or not.
Response:	The module responds with the Status Register byte which is 0xFF if the application register is unlocked and 0xFC if it is locked.
Command String:	XYCOZRDSR
Description:	<p>X—Rack number of the target module (Range: ASCII printable characters, 0 through 3)</p> <p>Y— Slot number of the target module. (Range: ASCII printable characters, 0 through 7)</p> <p>C0Z— Module type for the target. Specifying "C01" in this argument addresses a 443B101, specifying "C02" addresses a 443B102.</p> <p>RDSR— tells the module to read the Status Register byte.</p>
Response String:	Status Register byte in ASCII format.
Example:	<p>Command String: "06C02RDSR"</p> <p>Response String: "FC"</p> <p>The 443B102 in rack 0 and slot 6 is commanded to read the Status Byte of a TEDS device. In this case, the Status Register is 0xFC, indicating that the application register is locked.</p>



Command: LKAR

Purpose: Permanently copies and locks the data in the application register scratchpad of the TEDS chip (DS2430) into the application register.

WARNING: The application register cannot be unlocked after this command has been sent.

Response: The module responds with a "0" to tell the calling process the command has been received.

Command String: XYCOZLKAR

Description: X—Rack number of the target module (Range: ASCII printable characters, 0 through 3)
Y— Slot number of the target module. (Range: ASCII printable characters, 0 through 7)

C0Z— Module type for the target. Specifying "C01" in this argument addresses a 443B101, specifying "C02" addresses a 443B102.

LKAR— tells the module to permanently lock the application register.

Response String: "0"

Example: Command String: "06C02LKAR"
Response String: "0"

The 443B102 in rack 0 and slot 6 is commanded to lock the application register of a TEDS device.

Appendix B: Figures

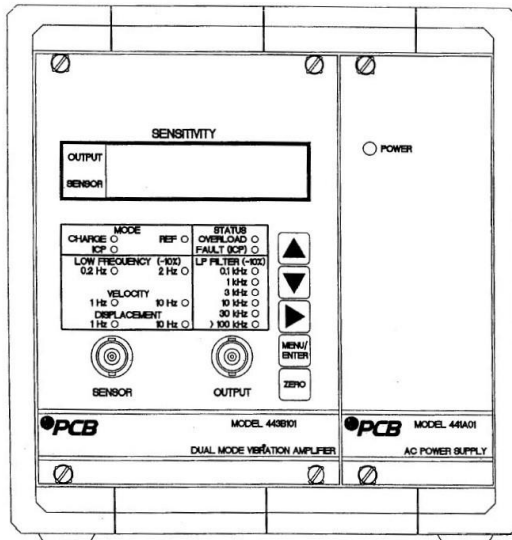

Figure 1: 443B101 UNIT FACE PLATE

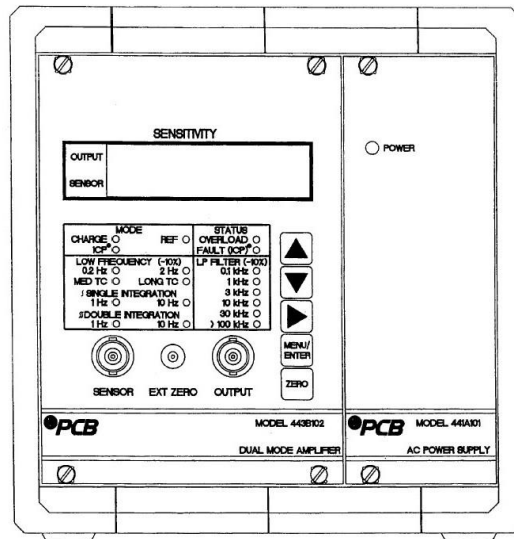

Figure 2: 443B102 UNIT FACE PLATE

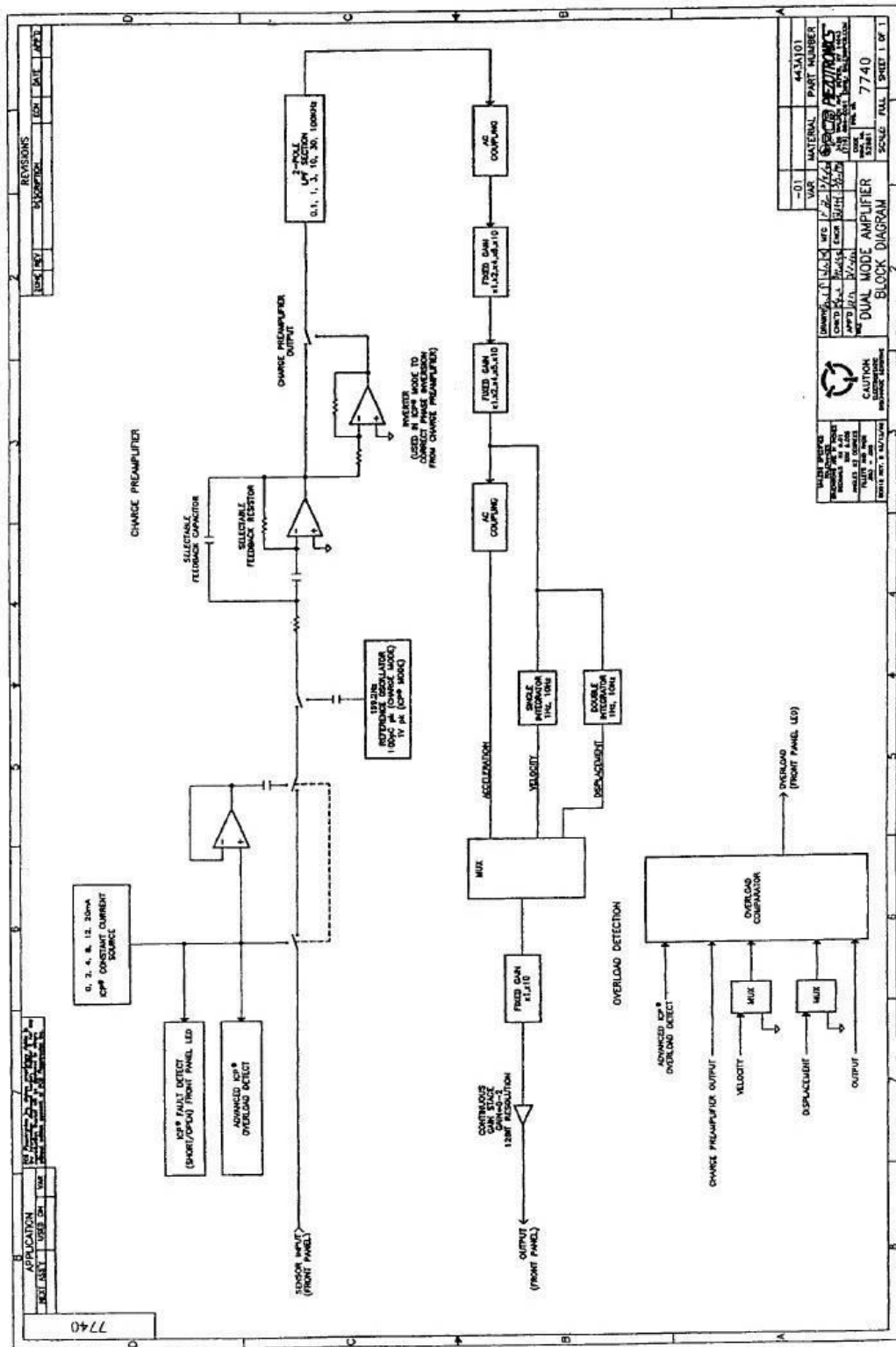

Figure 3: BLOCK DIAGRAM

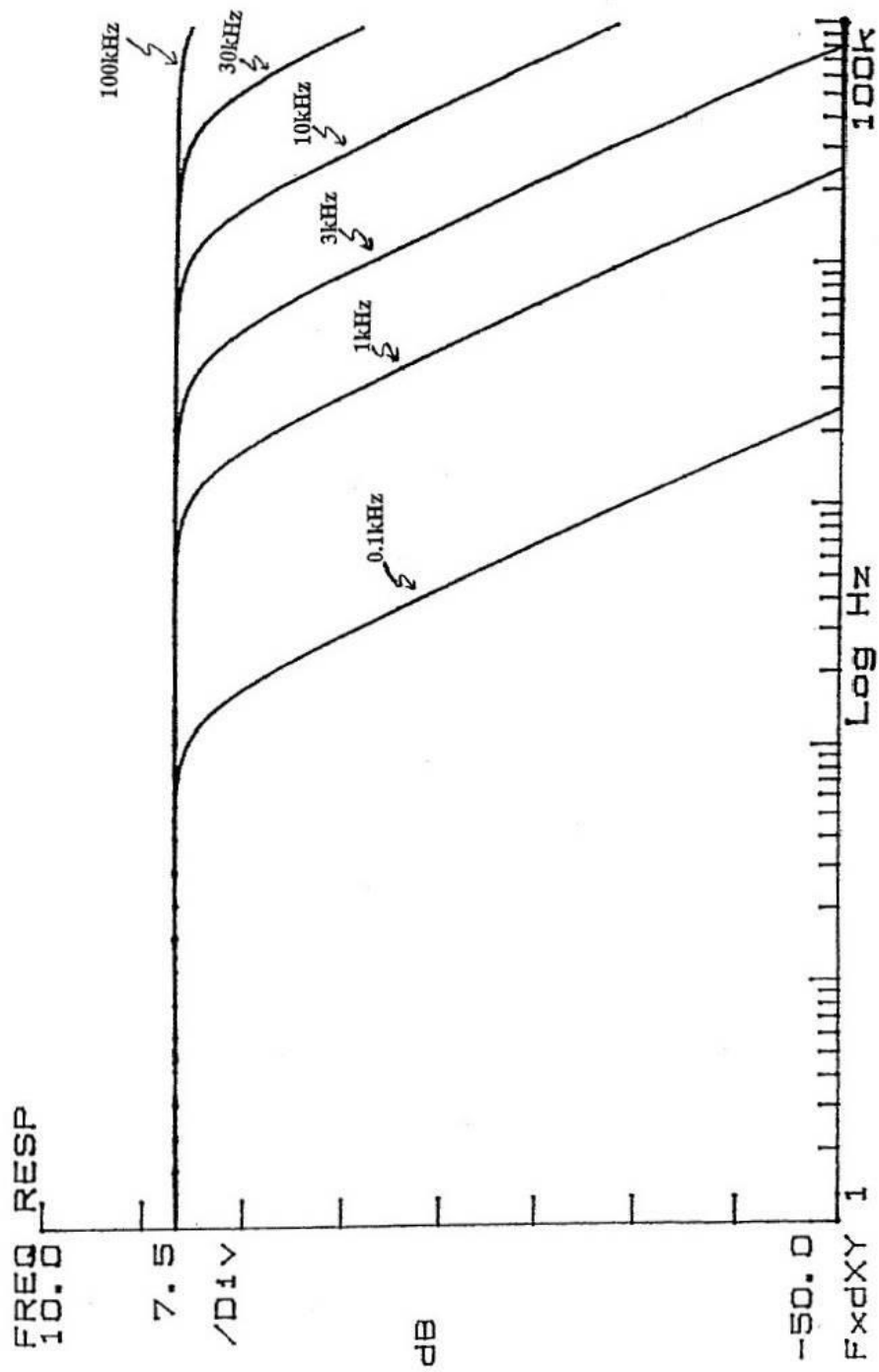

Figure 4: MAGNITUDE RESPONSE FOR LOW PASS FILTER IN CHARGE MODE
 (OUTPUT SENSITIVITY = 1.00 MV/UNIT, SENSOR SENSITIVITY = 1.000 PC/UNIT, 1 NF SOURCE)

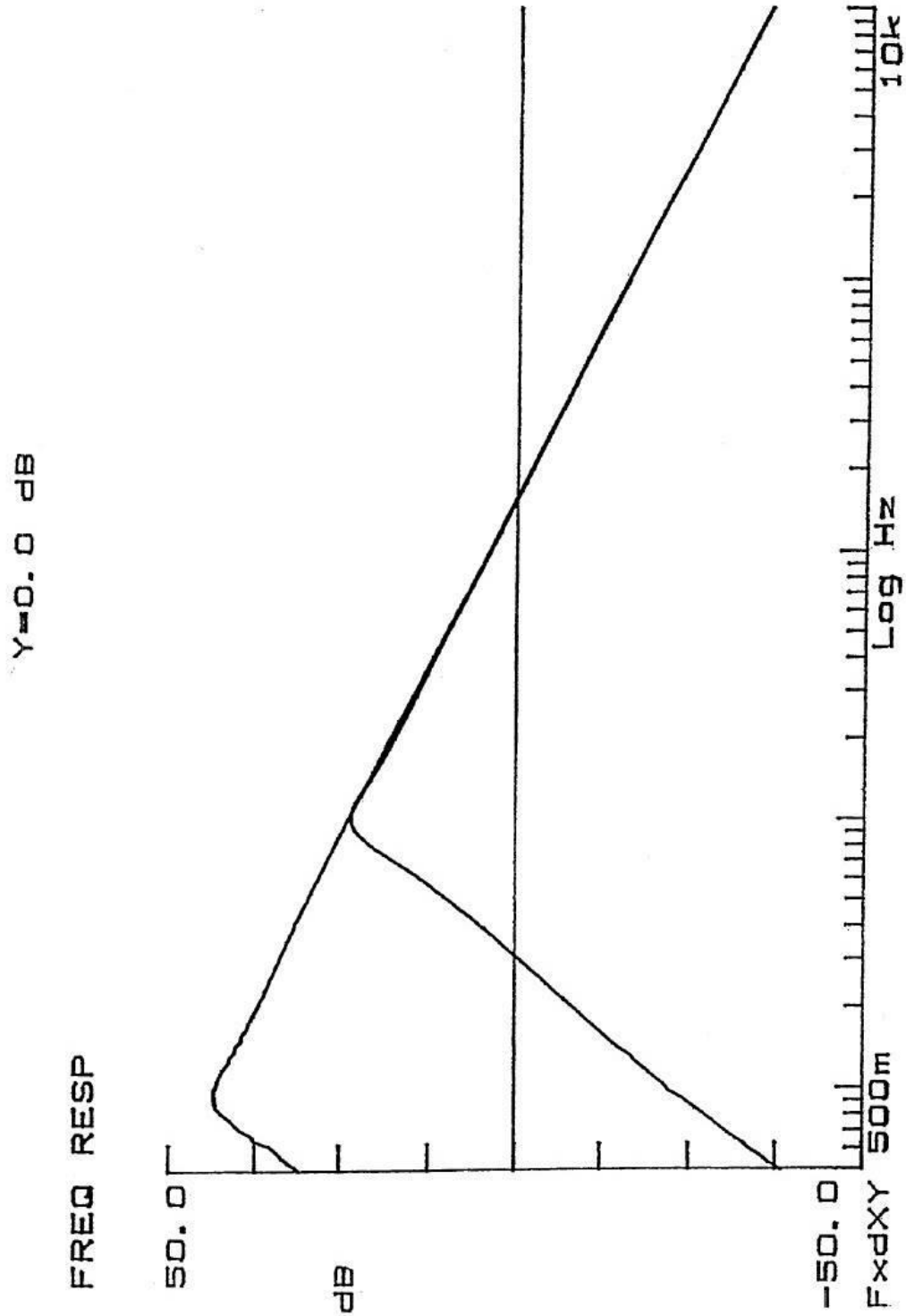

Figure 5: VELOCITY @ 1, 10 Hz (OUTPUT SENSITIVITY = 1000mV/m/S,
SENSOR SENSITIVITY = 1.000 pC/m/S², 1nF SOURCE)

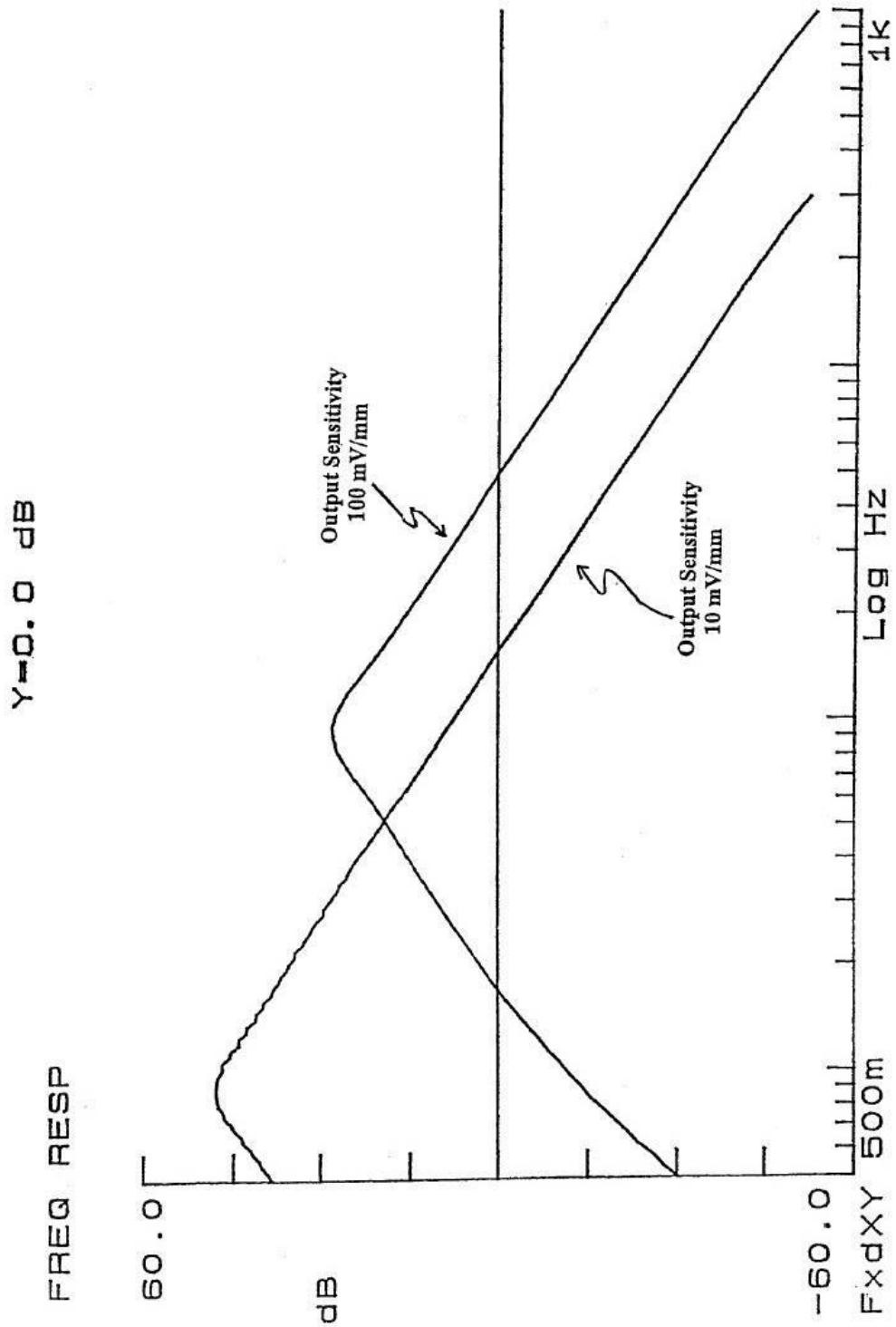

Figure 6: DISPLACEMENT @ 1, 10 Hz (SENSOR SENSITIVITY = 1.000 Pc/m/S², 1 nF SOURCE)

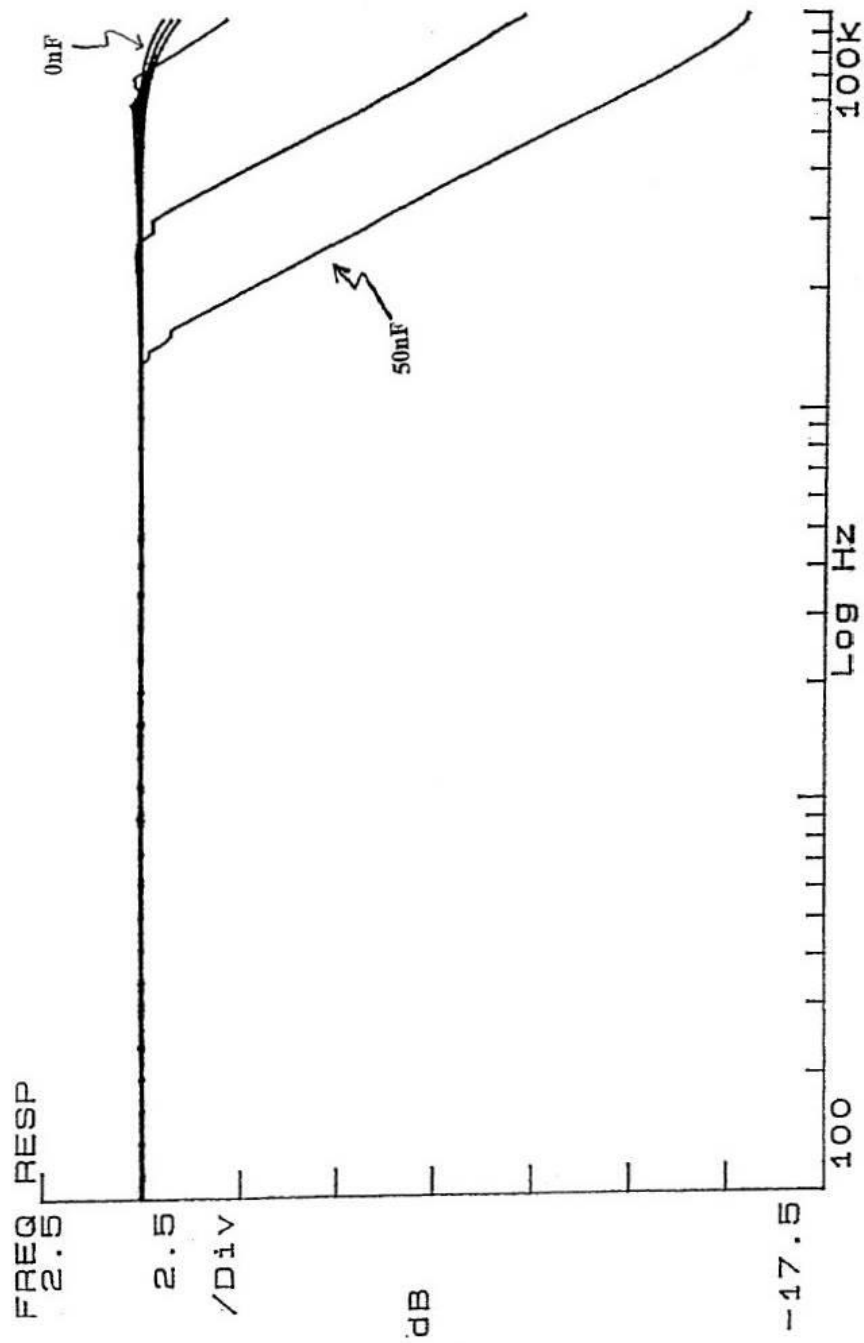

Figure 7: INFLUENCE OF OUTPUT LOAD CAPACITANCE ON FREQUENCY RESPONSE
(CAPACITATIVE LOAD = 0.5 nF, 20 nF, 50 nF, and 100 nF)



Model 441A101
MODULAR AC LINE POWER SUPPLY
Installation and Operating Manual

**For assistance with the operation of this product,
contact PCB Piezotronics, Inc.**

Toll-free: 800-828-8840
24-hour SensorLine: 716-684-0001
Fax: 716-684-0987
E-mail: info@pcb.com
Web: www.pcb.com



Repair and Maintenance

PCB guarantees Total Customer Satisfaction through its “Lifetime Warranty Plus” on all Platinum Stock Products sold by PCB and through its limited warranties on all other PCB Stock, Standard and Special products. Due to the sophisticated nature of our sensors and associated instrumentation, **field servicing and repair is not recommended and, if attempted, will void the factory warranty.**

Beyond routine calibration and battery replacements where applicable, our products require no user maintenance. Clean electrical connectors, housings, and mounting surfaces with solutions and techniques that will not harm the material of construction. Observe caution when using liquids near devices that are not hermetically sealed. Such devices should only be wiped with a dampened cloth—never saturated or submerged.

In the event that equipment becomes damaged or ceases to operate, our Application Engineers are here to support your troubleshooting efforts 24 hours a day, 7 days a week. Call or email with model and serial number as well as a brief description of the problem.

Calibration

Routine calibration of sensors and associated instrumentation is necessary to maintain measurement accuracy. We recommend calibrating on an annual basis, after exposure to any extreme environmental influence, or prior to any critical test.

PCB Piezotronics is an ISO-9001 certified company whose calibration services are accredited by A2LA to ISO/IEC 17025, with full traceability to SI through N.I.S.T. In addition to our standard calibration services, we also offer specialized tests, including: sensitivity at elevated or cryogenic temperatures, phase response, extended high or low frequency response, extended range, leak testing, hydrostatic pressure testing, and others. For more information, contact your local PCB Piezotronics distributor, sales representative, or factory customer service representative.

Returning Equipment

If factory repair is required, our representatives will provide you with a Return Material Authorization (RMA) number, which we use to reference any information you have already provided and expedite the repair process. This number should be clearly marked on the outside of all returned package(s) and on any packing list(s) accompanying the shipment.

Contact Information

PCB Piezotronics, Inc.
3425 Walden Ave.
Depew, NY14043 USA
Toll-free: (800) 828-8840
24-hour SensorLine: (716) 684-0001
General inquiries: info@pcb.com
Repair inquiries: rma@pcb.com

For a complete list of distributors, global offices and sales representatives, visit our website, www.pcb.com.

Safety Considerations

This product is intended for use by qualified personnel who recognize shock hazards and are familiar with the precautions required to avoid injury. While our equipment is designed with user safety in mind, the protection provided by the equipment may be impaired if equipment is used in a manner not specified by this manual.

Discontinue use and contact our 24-Hour Sensorline if:

- Assistance is needed to safely operate equipment
- Damage is visible or suspected
- Equipment fails or malfunctions

For complete equipment ratings, refer to the enclosed specification sheet for your product.

Definition of Terms and Symbols

The following symbols may be used in this manual:



DANGER

Indicates an immediate hazardous situation, which, if not avoided, may result in death or serious injury.

**CAUTION**

Refers to hazards that could damage the instrument.

**NOTE**

Indicates tips, recommendations and important information. The notes simplify processes and contain additional information on particular operating steps.

The following symbols may be found on the equipment described in this manual:



This symbol on the unit indicates that high voltage may be present. Use standard safety precautions to avoid personal contact with this voltage.



This symbol on the unit indicates that the user should refer to the operating instructions located in the manual.



This symbol indicates safety, earth ground.



PCB工业监视和测量设备 - 中国RoHS2公布表

PCB Industrial Monitoring and Measuring Equipment - China RoHS 2 Disclosure Table

部件名称	有害物质					
	铅 (Pb)	汞 (Hg)	镉 (Cd)	六价铬 (Cr(VI))	多溴联苯 (PBB)	多溴二苯醚 (PBDE)
住房	0	0	0	0	0	0
PCB板	X	0	0	0	0	0
电气连接器	0	0	0	0	0	0
压电晶体	X	0	0	0	0	0
环氧	0	0	0	0	0	0
铁氟龙	0	0	0	0	0	0
电子	0	0	0	0	0	0
厚膜基板	0	0	X	0	0	0
电线	0	0	0	0	0	0
电缆	X	0	0	0	0	0
塑料	0	0	0	0	0	0
焊接	X	0	0	0	0	0
铜合金/黄铜	X	0	0	0	0	0
本表格依据 SJ/T 11364 的规定编制。						
0：表示该有害物质在该部件所有均质材料中的含量均在 GB/T 26572 规定的限量要求以下。						
X：表示该有害物质至少在该部件的某一均质材料中的含量超出 GB/T 26572 规定的限量要求。						
铅是欧洲RoHS指令2011/65/ EU附件三和附件四目前由于允许的豁免。						

CHINA RoHS COMPLIANCE

Component Name	Hazardous Substances					
	Lead (Pb)	Mercury (Hg)	Cadmium (Cd)	Chromium VI Compounds (Cr(VI))	Polybrominated Biphenyls (PBB)	Polybrominated Diphenyl Ethers (PBDE)
Housing	O	O	O	O	O	O
PCB Board	X	O	O	O	O	O
Electrical Connectors	O	O	O	O	O	O
Piezoelectric Crystals	X	O	O	O	O	O
Epoxy	O	O	O	O	O	O
Teflon	O	O	O	O	O	O
Electronics	O	O	O	O	O	O
Thick Film Substrate	O	O	X	O	O	O
Wires	O	O	O	O	O	O
Cables	X	O	O	O	O	O
Plastic	O	O	O	O	O	O
Solder	X	O	O	O	O	O
Copper Alloy/Brass	X	O	O	O	O	O

This table is prepared in accordance with the provisions of SJ/T 11364.

O: Indicates that said hazardous substance contained in all of the homogeneous materials for this part is below the limit requirement of GB/T 26572.

X: Indicates that said hazardous substance contained in at least one of the homogeneous materials for this part is above the limit requirement of GB/T 26572.

Lead is present due to allowed exemption in Annex III or Annex IV of the European RoHS Directive 2011/65/EU.



- CHASSIS: MODELS 441A33, 441A35, 441A42, 441A43, 441A45 AND 441A49 2
 - EQUIPMENT RATINGS 2
 - MULTIPLE CHASSIS CONFIGURATION 2
 - CHANGING THE FUSE 2
 - DISABLING COOLING FAN 2

- AVAILABLE MODULES 2

- AC POWER SUPPLY: MODEL 441A101 3

- DC POWER SUPPLY: MODEL 441A102 3
 - OPERATION 3
 - CHARGING THE BATTERY 3

- APPENDIX A: FIGURES 4



Chassis: Models 441A33, 441A35, 441A42, 441A43, 441A45 and 441A49

The PCB Series 440 Modular Chassis is the enclosure into which the modules of the PCB Modular Signal Conditioning System are inserted. Its configuration varies by model, ranging from two slots to nine; one slot is reserved for the power supply, while Eurocard-style plug-in modules occupy the remaining slots and are secured to the inside frame using mechanical fasteners. A circuit board assembly in the rear of the chassis distributes power to the modules and provides the means by which modules communicate with each other, the rest of the system, and a personal computer.

Models 441A33, 441A35 and 441A38 are the computer-controlled, master versions of the standard chassis. The back panel of these master chassis have two RS-485 connectors marked IN and OUT and one RS-232 connector. Models 441A45 and 441A49 are slave chassis designed to be controlled by the masters. Slave chassis also have two RS-485 connectors, but no RS-232 connector. In a multiple chassis system, the master controller communicates to the other modules via the common RS-485 network and to the computer via the RS-232 connection.

Equipment Ratings

This equipment operates at 104°F (40°C), in an environment having 93% relative humidity. Its frequency range is 50/60 Hz. Operation of this unit is limited to environments having an altitude of less than 2 000 meters. The pollution degree for operation of the Model 440 is two (2), meaning that normally, only non-conductive pollution occurs. The over voltage category is II, indicating the transient voltage levels that may be tolerated by the equipment.

Multiple Chassis Configuration



High voltage electrostatic discharge (ESD) can damage electrical devices. To avoid triboelectric transfer:

1. Connect the cables only with the AC power off.
2. Temporarily "short" the end of the cable before attaching it to any signal input or output.

Each master controller can control up to four chassis filled with modules. Each chassis (or rack) must, however, be uniquely defined. This is accomplished by setting rack addresses. There are two jumpers on the upper right

portion of the backplane labeled RAD1 and RAD0, as shown on Figure 1 in Appendix A. The settings are as follows:

	RAD1	RAD0
Rack 1	Low	Low
Rack 2	Low	High
Rack 3	High	Low
Rack 4	High	High

Refer to Figure 2 in Appendix A for a four-rack configuration. Notice on the drawing that the RS-485 IN connection on Rack 1 requires termination, as does the 485 OUT connection on Rack 4. The 485 IN is terminated with the TER1, TER2 and TER3 terminators on the backplane. The termination settings are also shown.

Changing the Fuse

Two rear panel fuses, located below switch in the AC receptacle, protect the power line inputs of the instrument. The fuse type is a T 1.6A, L 250 V. To change the fuse, disconnect the power cord. Find the slot just above the power switch and pull forward to open the door that exposes the fuse drawers. Pull the individual drawer forward and insert a new fuse.

Slot – Carefully pry to expose fuse drawers.

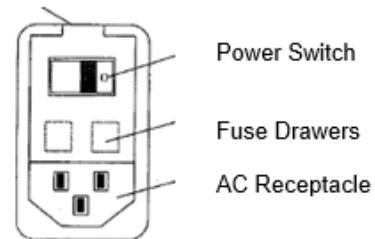

Disabling Cooling Fan

If it is necessary to turn off the cooling fan in order to reduce acoustical noise, a jumper "J2," located on the motherboard, must be removed. In order to access this jumper, the rear panel must be taken off. The fan may then be disabled via a command from the host computer controlling the master. The fan should be disabled for as short a period as possible to ensure continuous cooling. Contact the factory for more details.

Available Modules

For more information on individual modules, please see the individual manual accompanying each of the following:



- Model 442A102: Single-channel, line powered ICP® sensor signal conditioner, unity gain.
- Model 442A103: Single-channel, line powered ICP® sensor signal conditioner, with gain of x1, x10, x100.
- Model 442B104: Four-channel, line powered ICP® sensor signal conditioner, with gain of x1, x10, x100. Optional 477A-type plugin filters available.
- Model 442A101: Single-channel, line powered ICP® sensor signal conditioner, with gain of x1, x10, x100, AC/DC coupled.
- Model 443B101: Dual-mode ICP/charge amplifier – vibration (2-slot).
- Model 443B102 Dual-mode ICP/charge amplifier – pressure or force (2-slot).

AC Power Supply: Model 441A101

The Model 441A01 is a single-slot, CE marked, AC-line power supply designed to fit only the extreme right slot of the PCB Series 440 Modular Chassis. It supplies a maximum of 45 watts of power and may be used to operate single or multiple signal conditioning modules housed in the two-, three-, or nine-wide standard chassis and optional auxiliary chassis. Please note that while this unit is rated for a maximum wattage of 45, CE requirements mandate that it be used only up to 30 watts.

For wattage calculations, refer to the specification sheet for the individual module. To determine power capability of your particular set-up, add all the powers for all modules. CE mandates that these totals must be ≤ 30 watts.

DC Power Supply: Model 441A102

Model 441A102 is a single width, CE marked, rechargeable DC battery power supply that can be used in place of the 441A101 AC Power. Standard accessories include:

- Model 017A22 power cord
- Model 488A08 battery charger
- Built-in 3.0 Ah NiMH rechargeable battery

The optional Model 488A09 is a 12VDC @3.4A AC Power Adaptor that allows the 441A102 to be used with any AC line power in the world. (100-240VAC 50/60Hz).

The 441A102 can be used to power up to 30 watts of PCB modular series units. For wattage calculations, refer to the specification sheet for the individual module. To determine power capability of your particular set-up, add all the powers

for all modules. CE mandates that these totals must be ≤ 30 watts.

Operation

To operate, slide into the power supply slot of the PCB Series 440 Modular Chassis, tighten up the two mounting screws and turn the power switch to ON.



The 441A102 has some components that will get hot under heavy loads. Do not remove the module from the enclosures immediately after continuous heavy use. Let completely cool first.

Charging the Battery



It is not recommended to charge the 441A102 while the power switch is ON. No damage will occur, but charge time will increase.

To calculate the estimated battery life, divide 30 by the total number of watts of all the modules being used. Refer to module specification sheets for the number of watts to use in your calculation. To charge the battery:

1. Turn power off on the front panel of the 441A102.
2. Plug the Model 488A08 into the charger input jack.
3. The yellow charge light on the charger will light solid during fast charge as indicated on the charger. Typical charge time for a totally depleted battery is 1.5 to 2 hours.
4. After the battery is charged about 90%, the charge light will begin to blink (1/8 sec blink). If possible, leave charger on with charge light blinking for another few hours to get maximum charge.



Remove the charger plug by pulling on the body of the connector, not the cord. This is a locking feature to ensure a good connection while charging.



Appendix A: Figures

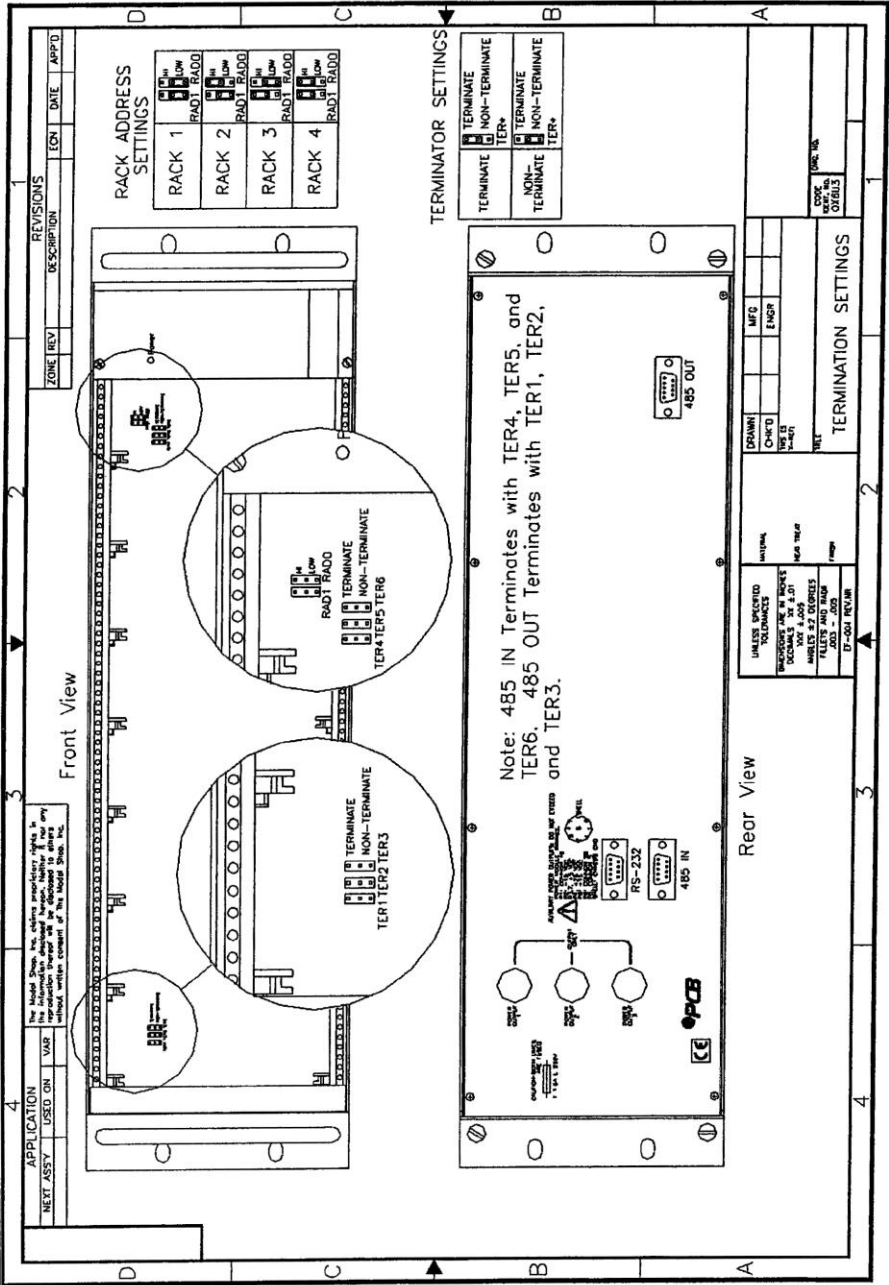

Figure 1: TERMINATION SETTINGS

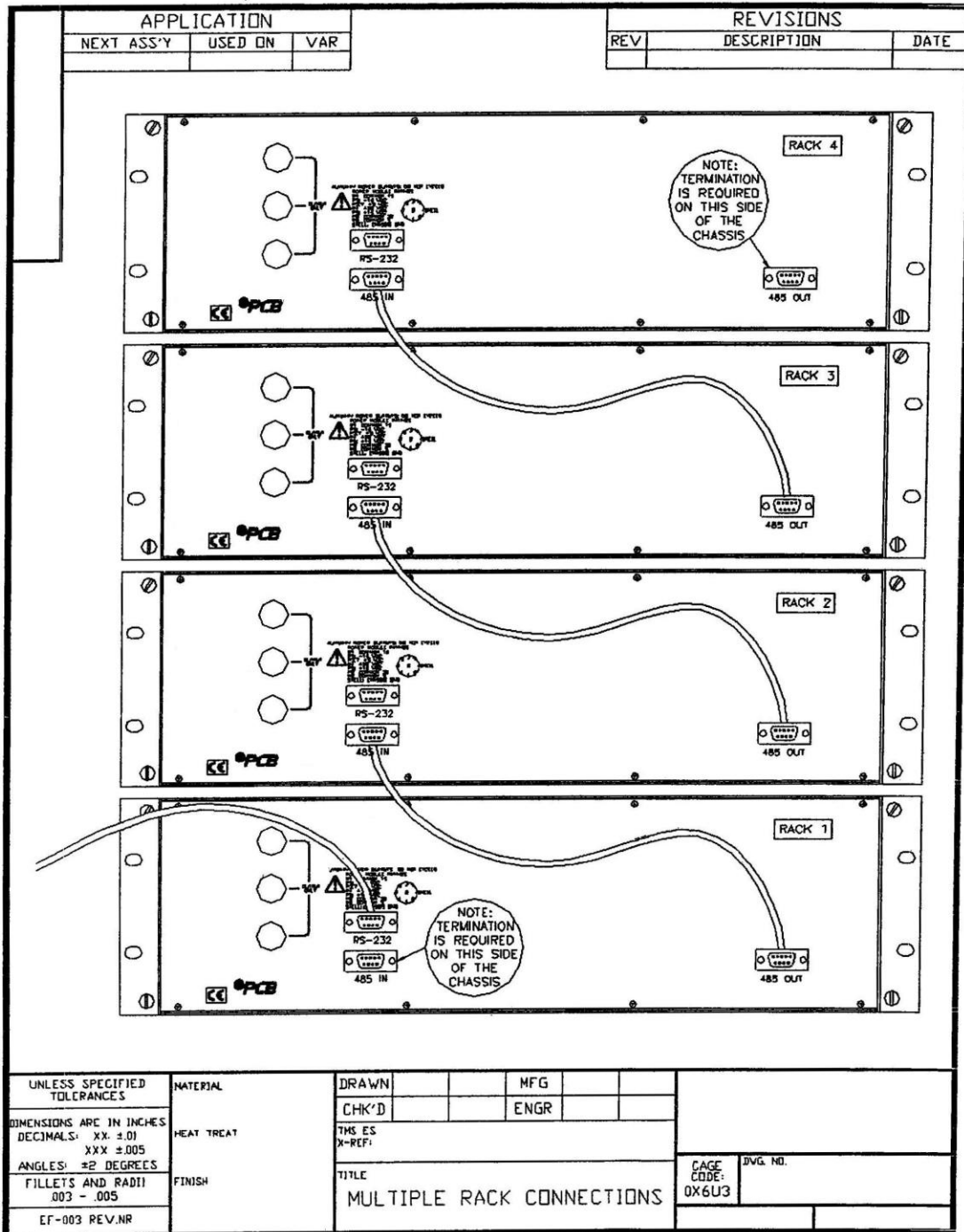

Figure 2: MULTIPLE CHASSIS CONFIGURATION



Model 443B02

MODULAR AC LINE POWER SUPPLY

Installation and Operating Manual

This manual contains the 441A101, 441A33, 443B102 installation and operating manuals that comprise a Model 443B02 MODULAR AC LINE POWER SUPPLY kit.

**For assistance with the operation of this product,
contact the PCB Piezotronics, Inc.**

Toll-free: 716-684-0001

24-hour SensorLine: 716-684-0001

Fax: 716-684-0987

E-mail: info@pcb.com

Web: www.pcb.com



Repair and Maintenance

PCB guarantees Total Customer Satisfaction through its “Lifetime Warranty Plus” on all Platinum Stock Products sold by PCB and through its limited warranties on all other PCB Stock, Standard and Special products. Due to the sophisticated nature of our sensors and associated instrumentation, **field servicing and repair is not recommended and, if attempted, will void the factory warranty.**

Beyond routine calibration and battery replacements where applicable, our products require no user maintenance. Clean electrical connectors, housings, and mounting surfaces with solutions and techniques that will not harm the material of construction. Observe caution when using liquids near devices that are not hermetically sealed. Such devices should only be wiped with a dampened cloth—never saturated or submerged.

In the event that equipment becomes damaged or ceases to operate, our Application Engineers are here to support your troubleshooting efforts 24 hours a day, 7 days a week. Call or email with model and serial number as well as a brief description of the problem.

Calibration

Routine calibration of sensors and associated instrumentation is necessary to maintain measurement accuracy. We recommend calibrating on an annual basis, after exposure to any extreme environmental influence, or prior to any critical test.

PCB Piezotronics is an ISO-9001 certified company whose calibration services are accredited by A2LA to ISO/IEC 17025, with full traceability to SI through N.I.S.T. In addition to our standard calibration services, we also offer specialized tests, including: sensitivity at elevated or cryogenic temperatures, phase response, extended high or low frequency response, extended range, leak testing, hydrostatic pressure testing, and others. For more information, contact your local PCB Piezotronics distributor, sales representative, or factory customer service representative.

Returning Equipment

If factory repair is required, our representatives will provide you with a Return Material Authorization (RMA) number, which we use to reference any information you have already provided and expedite the repair process. This number should be clearly marked on the outside of all returned package(s) and on any packing list(s) accompanying the shipment.

Contact Information

PCB Piezotronics, Inc.
3425 Walden Ave.
Depew, NY14043 USA
Toll-free: (800) 828-8840
24-hour SensorLine: (716) 684-0001
General inquiries: info@pcb.com
Repair inquiries: rma@pcb.com

For a complete list of distributors, global offices and sales representatives, visit our website, www.pcb.com.

Safety Considerations

This product is intended for use by qualified personnel who recognize shock hazards and are familiar with the precautions required to avoid injury. While our equipment is designed with user safety in mind, the protection provided by the equipment may be impaired if equipment is used in a manner not specified by this manual.

Discontinue use and contact our 24-Hour Sensorline if:

- Assistance is needed to safely operate equipment
- Damage is visible or suspected
- Equipment fails or malfunctions

For complete equipment ratings, refer to the enclosed specification sheet for your product.

Definition of Terms and Symbols

The following symbols may be used in this manual:



DANGER

Indicates an immediate hazardous situation, which, if not avoided, may result in death or serious injury.

**CAUTION**

Refers to hazards that could damage the instrument.

**NOTE**

Indicates tips, recommendations and important information. The notes simplify processes and contain additional information on particular operating steps.

The following symbols may be found on the equipment described in this manual:



This symbol on the unit indicates that high voltage may be present. Use standard safety precautions to avoid personal contact with this voltage.



This symbol on the unit indicates that the user should refer to the operating instructions located in the manual.



This symbol indicates safety, earth ground.



PCB工业监视和测量设备 - 中国RoHS2公布表

PCB Industrial Monitoring and Measuring Equipment - China RoHS 2 Disclosure Table

部件名称	有害物质					
	铅 (Pb)	汞 (Hg)	镉 (Cd)	六价铬 (Cr(VI))	多溴联苯 (PBB)	多溴二苯醚 (PBDE)
住房	0	0	0	0	0	0
PCB板	X	0	0	0	0	0
电气连接器	0	0	0	0	0	0
压电晶体	X	0	0	0	0	0
环氧	0	0	0	0	0	0
铁氟龙	0	0	0	0	0	0
电子	0	0	0	0	0	0
厚膜基板	0	0	X	0	0	0
电线	0	0	0	0	0	0
电缆	X	0	0	0	0	0
塑料	0	0	0	0	0	0
焊接	X	0	0	0	0	0
铜合金/黄铜	X	0	0	0	0	0
本表格依据 SJ/T 11364 的规定编制。						
0：表示该有害物质在该部件所有均质材料中的含量均在 GB/T 26572 规定的限量要求以下。						
X：表示该有害物质至少在该部件的某一均质材料中的含量超出 GB/T 26572 规定的限量要求。						
铅是欧洲RoHS指令2011/65/ EU附件三和附件四目前由于允许的豁免。						

CHINA RoHS COMPLIANCE

Component Name	Hazardous Substances					
	Lead (Pb)	Mercury (Hg)	Cadmium (Cd)	Chromium VI Compounds (Cr(VI))	Polybrominated Biphenyls (PBB)	Polybrominated Diphenyl Ethers (PBDE)
Housing	O	O	O	O	O	O
PCB Board	X	O	O	O	O	O
Electrical Connectors	O	O	O	O	O	O
Piezoelectric Crystals	X	O	O	O	O	O
Epoxy	O	O	O	O	O	O
Teflon	O	O	O	O	O	O
Electronics	O	O	O	O	O	O
Thick Film Substrate	O	O	X	O	O	O
Wires	O	O	O	O	O	O
Cables	X	O	O	O	O	O
Plastic	O	O	O	O	O	O
Solder	X	O	O	O	O	O
Copper Alloy/Brass	X	O	O	O	O	O

This table is prepared in accordance with the provisions of SJ/T 11364.

O: Indicates that said hazardous substance contained in all of the homogeneous materials for this part is below the limit requirement of GB/T 26572.

X: Indicates that said hazardous substance contained in at least one of the homogeneous materials for this part is above the limit requirement of GB/T 26572.

Lead is present due to allowed exemption in Annex III or Annex IV of the European RoHS Directive 2011/65/EU.



Model 441A33

3-slot chassis with computer control (for Series 440 modules)

Installation and Operating Manual

**For assistance with the operation of this product,
contact PCB Piezotronics, Inc.**

**Toll-free: 800-828-8840
24-hour SensorLine: 716-684-0001
Fax: 716-684-0987
E-mail: info@pcb.com
Web: www.pcb.com**



Repair and Maintenance

PCB guarantees Total Customer Satisfaction through its “Lifetime Warranty Plus” on all Platinum Stock Products sold by PCB and through its limited warranties on all other PCB Stock, Standard and Special products. Due to the sophisticated nature of our sensors and associated instrumentation, **field servicing and repair is not recommended and, if attempted, will void the factory warranty.**

Beyond routine calibration and battery replacements where applicable, our products require no user maintenance. Clean electrical connectors, housings, and mounting surfaces with solutions and techniques that will not harm the material of construction. Observe caution when using liquids near devices that are not hermetically sealed. Such devices should only be wiped with a dampened cloth—never saturated or submerged.

In the event that equipment becomes damaged or ceases to operate, our Application Engineers are here to support your troubleshooting efforts 24 hours a day, 7 days a week. Call or email with model and serial number as well as a brief description of the problem.

Calibration

Routine calibration of sensors and associated instrumentation is necessary to maintain measurement accuracy. We recommend calibrating on an annual basis, after exposure to any extreme environmental influence, or prior to any critical test.

PCB Piezotronics is an ISO-9001 certified company whose calibration services are accredited by A2LA to ISO/IEC 17025, with full traceability to SI through N.I.S.T. In addition to our standard calibration services, we also offer specialized tests, including: sensitivity at elevated or cryogenic temperatures, phase response, extended high or low frequency response, extended range, leak testing, hydrostatic pressure testing, and others. For more information, contact your local PCB Piezotronics distributor, sales representative, or factory customer service representative.

Returning Equipment

If factory repair is required, our representatives will provide you with a Return Material Authorization (RMA) number, which we use to reference any information you have already provided and expedite the repair process. This number should be clearly marked on the outside of all returned package(s) and on any packing list(s) accompanying the shipment.

Contact Information

PCB Piezotronics, Inc.
3425 Walden Ave.
Depew, NY14043 USA
Toll-free: (800) 828-8840
24-hour SensorLine: (716) 684-0001
General inquiries: info@pcb.com
Repair inquiries: rma@pcb.com

For a complete list of distributors, global offices and sales representatives, visit our website, www.pcb.com.

Safety Considerations

This product is intended for use by qualified personnel who recognize shock hazards and are familiar with the precautions required to avoid injury. While our equipment is designed with user safety in mind, the protection provided by the equipment may be impaired if equipment is used in a manner not specified by this manual.

Discontinue use and contact our 24-Hour Sensorline if:

- Assistance is needed to safely operate equipment
- Damage is visible or suspected
- Equipment fails or malfunctions

For complete equipment ratings, refer to the enclosed specification sheet for your product.

Definition of Terms and Symbols

The following symbols may be used in this manual:



DANGER

Indicates an immediate hazardous situation, which, if not avoided, may result in death or serious injury.

**CAUTION**

Refers to hazards that could damage the instrument.

**NOTE**

Indicates tips, recommendations and important information. The notes simplify processes and contain additional information on particular operating steps.

The following symbols may be found on the equipment described in this manual:



This symbol on the unit indicates that high voltage may be present. Use standard safety precautions to avoid personal contact with this voltage.



This symbol on the unit indicates that the user should refer to the operating instructions located in the manual.



This symbol indicates safety, earth ground.



PCB工业监视和测量设备 - 中国RoHS2公布表

PCB Industrial Monitoring and Measuring Equipment - China RoHS 2 Disclosure Table

部件名称	有害物质					
	铅 (Pb)	汞 (Hg)	镉 (Cd)	六价铬 (Cr(VI))	多溴联苯 (PBB)	多溴二苯醚 (PBDE)
住房	0	0	0	0	0	0
PCB板	X	0	0	0	0	0
电气连接器	0	0	0	0	0	0
压电晶体	X	0	0	0	0	0
环氧	0	0	0	0	0	0
铁氟龙	0	0	0	0	0	0
电子	0	0	0	0	0	0
厚膜基板	0	0	X	0	0	0
电线	0	0	0	0	0	0
电缆	X	0	0	0	0	0
塑料	0	0	0	0	0	0
焊接	X	0	0	0	0	0
铜合金/黄铜	X	0	0	0	0	0
本表格依据 SJ/T 11364 的规定编制。						
0：表示该有害物质在该部件所有均质材料中的含量均在 GB/T 26572 规定的限量要求以下。						
X：表示该有害物质至少在该部件的某一均质材料中的含量超出 GB/T 26572 规定的限量要求。						
铅是欧洲RoHS指令2011/65/ EU附件三和附件四目前由于允许的豁免。						

CHINA RoHS COMPLIANCE

Component Name	Hazardous Substances					
	Lead (Pb)	Mercury (Hg)	Cadmium (Cd)	Chromium VI Compounds (Cr(VI))	Polybrominated Biphenyls (PBB)	Polybrominated Diphenyl Ethers (PBDE)
Housing	O	O	O	O	O	O
PCB Board	X	O	O	O	O	O
Electrical Connectors	O	O	O	O	O	O
Piezoelectric Crystals	X	O	O	O	O	O
Epoxy	O	O	O	O	O	O
Teflon	O	O	O	O	O	O
Electronics	O	O	O	O	O	O
Thick Film Substrate	O	O	X	O	O	O
Wires	O	O	O	O	O	O
Cables	X	O	O	O	O	O
Plastic	O	O	O	O	O	O
Solder	X	O	O	O	O	O
Copper Alloy/Brass	X	O	O	O	O	O

This table is prepared in accordance with the provisions of SJ/T 11364.

O: Indicates that said hazardous substance contained in all of the homogeneous materials for this part is below the limit requirement of GB/T 26572.

X: Indicates that said hazardous substance contained in at least one of the homogeneous materials for this part is above the limit requirement of GB/T 26572.

Lead is present due to allowed exemption in Annex III or Annex IV of the European RoHS Directive 2011/65/EU.

Model Number
441A33

MODULAR SERIES THREE WIDE ENCLOSURE WITH ON-BOARD COMPUTER INTERFACE CONTROLLER

Revision: F
ECN #: 16009

PHYSICAL

Size (H x W x L):	in	6.2 x 6.1 x 10.2	
	[cm]	[16 x 15 x 26]	
Available Module Space	width	27 HP	[1]
Weight	lb [kg]	3.3 [1,5]	[2]

ELECTRICAL

Communication Ports:			
Computer I/O Connector	type	RS-232 (DB9S)	
Optional I/O Connectors	type	RS-485 (DB9P)	[4]
Electrical Power Connectors: Input AC (line)	type	IEC 320	[3]

NOTES:

- [1] Requires one 9 HP wide power module, leaving 18 HP available for signal conditioning modules. (Typical signal conditioners are either 9 HP or 18 HP wide. Consult appropriate specification.)
- [2] Empty weight with no modules.
- [3] Not used when operated with Model 441A102 Battery Power Module.
- [4] For use in multi-rack systems.
- [5] Except when 441A33 is part of a 443B01 or 443B02 system.
- [6] See PCB Declaration of Conformance PS024 for details.

SUPPLIED ACCESSORIES:

- Series 017 Power Cord
- Ferrite Bead (part number 100-2973-30) (1)
- 400A17 Blank Panel (1)
- RS-232 Cable (Shielded) DB9P to DB9S (part number 100-7103-50)
- Ferrite Bead (part number 100-7102-20) (1)

OPTIONAL ACCESSORIES:

- RS-485 Cable (Shielded) DB9S to DB9S (part number 100-7103-60)
- Ferrite Bead (part number 100-7102-20) (1)



All specifications are at room temperature unless otherwise specified.

ICP[®] is a registered trademark of PCB Piezotronics, Inc.

In the interest of constant product improvement, we reserve the right to change specifications without notice.

Drawn: BLS	Engineer: PMA	Sales: BJA	Approved: RJV	Spec Number:
Date: 1-19-04	Date: 1-20-04	Date: 1-21-04	Date: 1/21/04	12148



Model 443B102
Dual Mode Modular Signal Conditioner Card
Installation and Operating Manual

**For assistance with the operation of this product,
contact PCB Piezotronics, Inc.**

Toll-free: 800-828-8840
24-hour SensorLine: 716-684-0001
Fax: 716-684-0987
E-mail: info@pcb.com
Web: www.pcb.com



Repair and Maintenance

PCB guarantees Total Customer Satisfaction through its “Lifetime Warranty Plus” on all Platinum Stock Products sold by PCB and through its limited warranties on all other PCB Stock, Standard and Special products. Due to the sophisticated nature of our sensors and associated instrumentation, **field servicing and repair is not recommended and, if attempted, will void the factory warranty.**

Beyond routine calibration and battery replacements where applicable, our products require no user maintenance. Clean electrical connectors, housings, and mounting surfaces with solutions and techniques that will not harm the material of construction. Observe caution when using liquids near devices that are not hermetically sealed. Such devices should only be wiped with a dampened cloth—never saturated or submerged.

In the event that equipment becomes damaged or ceases to operate, our Application Engineers are here to support your troubleshooting efforts 24 hours a day, 7 days a week. Call or email with model and serial number as well as a brief description of the problem.

Calibration

Routine calibration of sensors and associated instrumentation is necessary to maintain measurement accuracy. We recommend calibrating on an annual basis, after exposure to any extreme environmental influence, or prior to any critical test.

PCB Piezotronics is an ISO-9001 certified company whose calibration services are accredited by A2LA to ISO/IEC 17025, with full traceability to SI through N.I.S.T. In addition to our standard calibration services, we also offer specialized tests, including: sensitivity at elevated or cryogenic temperatures, phase response, extended high or low frequency response, extended range, leak testing, hydrostatic pressure testing, and others. For more information, contact your local PCB Piezotronics distributor, sales representative, or factory customer service representative.

Returning Equipment

If factory repair is required, our representatives will provide you with a Return Material Authorization (RMA) number, which we use to reference any information you have already provided and expedite the repair process. This number should be clearly marked on the outside of all returned package(s) and on any packing list(s) accompanying the shipment.

Contact Information

PCB Piezotronics, Inc.
3425 Walden Ave.
Depew, NY14043 USA
Toll-free: (800) 828-8840
24-hour SensorLine: (716) 684-0001
General inquiries: info@pcb.com
Repair inquiries: rma@pcb.com

For a complete list of distributors, global offices and sales representatives, visit our website, www.pcb.com.

Safety Considerations

This product is intended for use by qualified personnel who recognize shock hazards and are familiar with the precautions required to avoid injury. While our equipment is designed with user safety in mind, the protection provided by the equipment may be impaired if equipment is used in a manner not specified by this manual.

Discontinue use and contact our 24-Hour Sensorline if:

- Assistance is needed to safely operate equipment
- Damage is visible or suspected
- Equipment fails or malfunctions

For complete equipment ratings, refer to the enclosed specification sheet for your product.

Definition of Terms and Symbols

The following symbols may be used in this manual:



DANGER

Indicates an immediate hazardous situation, which, if not avoided, may result in death or serious injury.

**CAUTION**

Refers to hazards that could damage the instrument.

**NOTE**

Indicates tips, recommendations and important information. The notes simplify processes and contain additional information on particular operating steps.

The following symbols may be found on the equipment described in this manual:



This symbol on the unit indicates that high voltage may be present. Use standard safety precautions to avoid personal contact with this voltage.



This symbol on the unit indicates that the user should refer to the operating instructions located in the manual.



This symbol indicates safety, earth ground.



PCB工业监视和测量设备 - 中国RoHS2公布表

PCB Industrial Monitoring and Measuring Equipment - China RoHS 2 Disclosure Table

部件名称	有害物质					
	铅 (Pb)	汞 (Hg)	镉 (Cd)	六价铬 (Cr(VI))	多溴联苯 (PBB)	多溴二苯醚 (PBDE)
住房	0	0	0	0	0	0
PCB板	X	0	0	0	0	0
电气连接器	0	0	0	0	0	0
压电晶体	X	0	0	0	0	0
环氧	0	0	0	0	0	0
铁氟龙	0	0	0	0	0	0
电子	0	0	0	0	0	0
厚膜基板	0	0	X	0	0	0
电线	0	0	0	0	0	0
电缆	X	0	0	0	0	0
塑料	0	0	0	0	0	0
焊接	X	0	0	0	0	0
铜合金/黄铜	X	0	0	0	0	0
本表格依据 SJ/T 11364 的规定编制。						
0：表示该有害物质在该部件所有均质材料中的含量均在 GB/T 26572 规定的限量要求以下。						
X：表示该有害物质至少在该部件的某一均质材料中的含量超出 GB/T 26572 规定的限量要求。						
铅是欧洲RoHS指令2011/65/ EU附件三和附件四目前由于允许的豁免。						

CHINA RoHS COMPLIANCE

Component Name	Hazardous Substances					
	Lead (Pb)	Mercury (Hg)	Cadmium (Cd)	Chromium VI Compounds (Cr(VI))	Polybrominated Biphenyls (PBB)	Polybrominated Diphenyl Ethers (PBDE)
Housing	O	O	O	O	O	O
PCB Board	X	O	O	O	O	O
Electrical Connectors	O	O	O	O	O	O
Piezoelectric Crystals	X	O	O	O	O	O
Epoxy	O	O	O	O	O	O
Teflon	O	O	O	O	O	O
Electronics	O	O	O	O	O	O
Thick Film Substrate	O	O	X	O	O	O
Wires	O	O	O	O	O	O
Cables	X	O	O	O	O	O
Plastic	O	O	O	O	O	O
Solder	X	O	O	O	O	O
Copper Alloy/Brass	X	O	O	O	O	O

This table is prepared in accordance with the provisions of SJ/T 11364.

O: Indicates that said hazardous substance contained in all of the homogeneous materials for this part is below the limit requirement of GB/T 26572.

X: Indicates that said hazardous substance contained in at least one of the homogeneous materials for this part is above the limit requirement of GB/T 26572.

Lead is present due to allowed exemption in Annex III or Annex IV of the European RoHS Directive 2011/65/EU.

Model Number 443B102		MODULAR SERIES POWER SUPPLY		Revision: F ECN #: 47122	
Performance	ENGLISH	SI	OPTIONAL VERSIONS		
Sensor Input Type(s)	ICP®, Charge	ICP®, Charge	Optional versions have identical specifications and accessories as listed for the standard model except where noted below. More than one option may be used.		
Voltage Gain Increment	0.1-1000	0.1-1000			
Accuracy(ICP®/ Voltage Input)	± 0.5 %	± 0.5 %			
Accuracy(Charge Input)	± 0.5 %	± 0.5 %			
Sensitivity(ICP®/Voltage)	.001 to 9.999 mV/unit	.001 to 9.999 mV/unit	[11]		
Sensitivity(Charge Input)	0.0001 to 10 V/pC	0.0001 to 10 V/pC			
Input Range(maximum)(Charge Input)	100,000 pC	100,000 pC	[12]		
Low Frequency Response(-10 %)	2.0 Hz ±20 %	2.0 Hz ±20 %			
Low Frequency Response(-10 %)	0.2 Hz ±20 %	0.2 Hz ±20 %			
Low Frequency Response(10 %)(Velocity)	1.0 Hz ±5 %	1.0 Hz ±5 %			
Low Frequency Response(10 %)(Velocity)	10 Hz ±5 %	10 Hz ±5 %			
Low Frequency Response(10 %)(Displacement)	1.0 Hz ±5 %	1.0 Hz ±5 %			
Low Frequency Response(10 %)(Displacement)	10 Hz ±5 %	10 Hz ±5 %			
High Frequency Response(-10 %)	200 kHz ±5 %	200 kHz ±5 %			
Filter Type(4-pole Butterworth)	Low Pass	Low Pass			
Electrical Filter Roll-off	80 dB/decade	80 dB/decade			
High Frequency Response(-10 %)	0.1 kHz ±5 %	0.1 kHz ±5 %			
High Frequency Response(-10 %)	1.0 kHz ±5 %	1.0 kHz ±5 %			
High Frequency Response(-10 %)	3.0 kHz ±5 %	3.0 kHz ±5 %			
High Frequency Response(-10 %)	10 kHz ±5 %	10 kHz ±5 %			
High Frequency Response(-10 %)	30 kHz ±5 %	30 kHz ±5 %			
High Frequency Response(-10 %)	100 kHz ±5 %	100 kHz ±5 %			
Fault/Bias Monitor LEADS	Fault/Overload	Fault/Overload			
Drift	<0.03 pC/s	<0.03 pC/s	[13]		
Control Interface					
Human Interface	Keypad	Keypad			
Display	2 rows, 16 columns	2 rows, 16 columns			
Digital Control Interface	RS-485	RS-485	[1]		
Digital Control: Data Rate	9600 bps	9600 bps			
Digital Control: Start, Data, Stop, Parity	1, 8, 1, No	1, 8, 1, No			
Environmental					
Temperature Range(Operating)	32 to 120 °F	0 to +50 °C			
Electrical					
Power Required(VDC)	+15 at 230 mA	+15 at 230 mA			
Power Required(VDC)	-15 at 140 mA	-15 at 140 mA			
Power Required(Watts)	6.25	6.25	[2]		
Power Required(VDC)	+28 at 5 mA + Sensor	+28 at 5 mA + Sensor			
Excitation Voltage(To Sensor)	Current	Current			
DC Offset	24 ±1 VDC	24 ±1 VDC			
Constant Current Excitation(to Sensor, Selectable)	<50 mV	<50 mV			
Output Voltage	0 to 20 mA	0 to 20 mA	[3]		
Output Impedance	>±10 V	>±10 V	[4]		
Broadband Electrical Noise(1 Hz to 10 kHz)(ICP® INPUT)	<1 Ohm	<1 Ohm			
Broadband Electrical Noise(2 to 22.4 kHz)(ICP® INPUT)	9 µV	-101 dB	[5][6]		
Spectral Noise(1 Hz)	<3 µV	<-110 dB	[5][6]		
Spectral Noise(10 Hz)	1 µV/√Hz	-120 dB	[6]		
Spectral Noise(100 Hz)	0.22 µV/√Hz	-133 dB	[6]		
Spectral Noise(1 kHz)	0.08 µV/√Hz	-142 dB	[6]		
Spectral Noise(10 kHz)	0.08 µV/√Hz	-142 dB	[6]		
Broadband Electrical Noise(1 Hz to 10 kHz)(Charge Input)	0.07 µV/√Hz	-143 dB	[6]		
Broadband Electrical Noise(2 Hz to 22.4 kHz)(Charge Input)	9 µV	-101 dB	[7][8]		
Spectral Noise(1 kHz)	<5 fC	<5 fC	[7][8]		
Spectral Noise(10 kHz)	0.8 µV/√Hz	-122 dB	[7]		
Spectral Noise(100 kHz)	0.20 µV/√Hz	-134 dB	[7]		
Spectral Noise(1 kHz)	0.08 µV/√Hz	-142 dB	[7]		
Spectral Noise(10 kHz)	0.08 µV/√Hz	-142 dB	[7]		
Spectral Noise(100 kHz)	0.07 µV/√Hz	-143 dB	[7]		
Oscillator(pC RMS)	100±1%	100±1%			
Oscillator(V RMS)	±1%	±1%			
Oscillator(Hz)	159.2±1%	159.2±1%			
Time Constant(Long TC Mode)	Up to 100,000	Up to 100,000	[9][10]		
Time Constant(Med TC Mode)	10, 100, 1,000 ±20%	10, 100, 1,000 ±20%			
Overload Threshold	± 10 V to ± 1 V	± 10 V to ± 1 V			
Physical					
Electrical Connector(Input, sensor)	BNC	BNC			
Electrical Connector(Output)	BNC	BNC			
Electrical Connector(Ext Zero)	SMB	SMB			
Size (Height)	5.05 x 3.6 in	128 x 92 mm	[14]		
Weight	1.45 lb	0.66 kg			
<p><i>All specifications are at room temperature unless otherwise specified. In the interest of constant product improvement, we reserve the right to change specifications without notice.</i></p> <p>ICP® is a registered trademark of PCB Group, Inc.</p>					
<p>NOTES:</p> <p>[1] Must be used with PCB 440 series mainframe chassis with computer control (RS-232). [2] Maximum number of 443B102 Dual Mode Signal Conditioners that can be powered by (1) 441A101 is (4). Other modules must be calculated not to exceed total power of 30 watts. [3] Discrete mA settings (0, 2, 4, 8, 12, or 20). [4] In medium time constant mode, output range is limited to ±8V for certain gain settings [5] Measured at gain of 1,000 (60 dB), input referred. [6] Measured at gain of 1 with low noise ICP® simulator. (High pass filter = 0.2Hz) [7] Measured at gain of 1 mV/pC with 1 nF source capacitance. [8] Measured at gain of 10V/pC (80 dB) with 1 nF source capacitance, input referred. [9] Depends on gain setting. LCD displays value when gain is entered. [10] When in ICP® mode, long TC is true DC response. [11] 4 Digit - Selectable [12] Can be increased using optional external 472B series charge attenuator. [13] Long time constant charge mode only. [14] Double width unit.</p>					
<p>SUPPLIED ACCESSORIES:</p> <p>Model 070A02 Scope input adaptor (10-32 jack to BNC plug) Model EE-79 443B Control Software (1 CD ROM)</p>					
Entered: LK	Engineer: CPH	Sales: WDC	Approved: DY	Spec Number:	
Date: 1/29/2018	Date: 1/29/2018	Date: 1/29/2018	Date: 1/29/2018	14471	
			<p>Phone: 716-684-0001 Fax: 716-684-0987 E-Mail: info@pcb.com</p>		
<p>3425 Walden Avenue, Depew, NY 14043</p>					



Model 441A101
MODULAR AC LINE POWER SUPPLY
Installation and Operating Manual

**For assistance with the operation of this product,
contact PCB Piezotronics, Inc.**

Toll-free: 800-828-8840
24-hour SensorLine: 716-684-0001
Fax: 716-684-0987
E-mail: info@pcb.com
Web: www.pcb.com



Repair and Maintenance

PCB guarantees Total Customer Satisfaction through its “Lifetime Warranty Plus” on all Platinum Stock Products sold by PCB and through its limited warranties on all other PCB Stock, Standard and Special products. Due to the sophisticated nature of our sensors and associated instrumentation, **field servicing and repair is not recommended and, if attempted, will void the factory warranty.**

Beyond routine calibration and battery replacements where applicable, our products require no user maintenance. Clean electrical connectors, housings, and mounting surfaces with solutions and techniques that will not harm the material of construction. Observe caution when using liquids near devices that are not hermetically sealed. Such devices should only be wiped with a dampened cloth—never saturated or submerged.

In the event that equipment becomes damaged or ceases to operate, our Application Engineers are here to support your troubleshooting efforts 24 hours a day, 7 days a week. Call or email with model and serial number as well as a brief description of the problem.

Calibration

Routine calibration of sensors and associated instrumentation is necessary to maintain measurement accuracy. We recommend calibrating on an annual basis, after exposure to any extreme environmental influence, or prior to any critical test.

PCB Piezotronics is an ISO-9001 certified company whose calibration services are accredited by A2LA to ISO/IEC 17025, with full traceability to SI through N.I.S.T. In addition to our standard calibration services, we also offer specialized tests, including: sensitivity at elevated or cryogenic temperatures, phase response, extended high or low frequency response, extended range, leak testing, hydrostatic pressure testing, and others. For more information, contact your local PCB Piezotronics distributor, sales representative, or factory customer service representative.

Returning Equipment

If factory repair is required, our representatives will provide you with a Return Material Authorization (RMA) number, which we use to reference any information you have already provided and expedite the repair process. This number should be clearly marked on the outside of all returned package(s) and on any packing list(s) accompanying the shipment.

Contact Information

PCB Piezotronics, Inc.
3425 Walden Ave.
Depew, NY14043 USA
Toll-free: (800) 828-8840
24-hour SensorLine: (716) 684-0001
General inquiries: info@pcb.com
Repair inquiries: rma@pcb.com

For a complete list of distributors, global offices and sales representatives, visit our website, www.pcb.com.

Safety Considerations

This product is intended for use by qualified personnel who recognize shock hazards and are familiar with the precautions required to avoid injury. While our equipment is designed with user safety in mind, the protection provided by the equipment may be impaired if equipment is used in a manner not specified by this manual.

Discontinue use and contact our 24-Hour Sensorline if:

- Assistance is needed to safely operate equipment
- Damage is visible or suspected
- Equipment fails or malfunctions

For complete equipment ratings, refer to the enclosed specification sheet for your product.

Definition of Terms and Symbols

The following symbols may be used in this manual:



DANGER

Indicates an immediate hazardous situation, which, if not avoided, may result in death or serious injury.

**CAUTION**

Refers to hazards that could damage the instrument.

**NOTE**

Indicates tips, recommendations and important information. The notes simplify processes and contain additional information on particular operating steps.

The following symbols may be found on the equipment described in this manual:



This symbol on the unit indicates that high voltage may be present. Use standard safety precautions to avoid personal contact with this voltage.



This symbol on the unit indicates that the user should refer to the operating instructions located in the manual.



This symbol indicates safety, earth ground.



PCB工业监视和测量设备 - 中国RoHS2公布表

PCB Industrial Monitoring and Measuring Equipment - China RoHS 2 Disclosure Table

部件名称	有害物质					
	铅 (Pb)	汞 (Hg)	镉 (Cd)	六价铬 (Cr(VI))	多溴联苯 (PBB)	多溴二苯醚 (PBDE)
住房	0	0	0	0	0	0
PCB板	X	0	0	0	0	0
电气连接器	0	0	0	0	0	0
压电晶体	X	0	0	0	0	0
环氧	0	0	0	0	0	0
铁氟龙	0	0	0	0	0	0
电子	0	0	0	0	0	0
厚膜基板	0	0	X	0	0	0
电线	0	0	0	0	0	0
电缆	X	0	0	0	0	0
塑料	0	0	0	0	0	0
焊接	X	0	0	0	0	0
铜合金/黄铜	X	0	0	0	0	0
本表格依据 SJ/T 11364 的规定编制。						
0：表示该有害物质在该部件所有均质材料中的含量均在 GB/T 26572 规定的限量要求以下。						
X：表示该有害物质至少在该部件的某一均质材料中的含量超出 GB/T 26572 规定的限量要求。						
铅是欧洲RoHS指令2011/65/ EU附件三和附件四目前由于允许的豁免。						

CHINA RoHS COMPLIANCE

Component Name	Hazardous Substances					
	Lead (Pb)	Mercury (Hg)	Cadmium (Cd)	Chromium VI Compounds (Cr(VI))	Polybrominated Biphenyls (PBB)	Polybrominated Diphenyl Ethers (PBDE)
Housing	O	O	O	O	O	O
PCB Board	X	O	O	O	O	O
Electrical Connectors	O	O	O	O	O	O
Piezoelectric Crystals	X	O	O	O	O	O
Epoxy	O	O	O	O	O	O
Teflon	O	O	O	O	O	O
Electronics	O	O	O	O	O	O
Thick Film Substrate	O	O	X	O	O	O
Wires	O	O	O	O	O	O
Cables	X	O	O	O	O	O
Plastic	O	O	O	O	O	O
Solder	X	O	O	O	O	O
Copper Alloy/Brass	X	O	O	O	O	O

This table is prepared in accordance with the provisions of SJ/T 11364.

O: Indicates that said hazardous substance contained in all of the homogeneous materials for this part is below the limit requirement of GB/T 26572.

X: Indicates that said hazardous substance contained in at least one of the homogeneous materials for this part is above the limit requirement of GB/T 26572.

Lead is present due to allowed exemption in Annex III or Annex IV of the European RoHS Directive 2011/65/EU.

Model Number
441A101

MODULAR AC LINE POWER SUPPLY

Revision: E
ECN #: 23396

AC POWER SUPPLY

Input Power:	VAC	100-240	
	Hz	50/60	
	amps	1.3	
Output Power	W	30	
Output Voltage:	VDC	+5 +0.025V, -0.00V	[2]
	VDC	+27 +3V, -.5V	[2]
	VDC	+15 ±0.45V	[2]
	VDC	-15 ±0.45V	[2]

ENVIRONMENTAL

Operating Temperature Range °F [°C] 32 to +120 [0 to +50]

PHYSICAL

Size (H x W): in [mm] 5.05 x 1.8 [128 x 46] [1]
Weight lb [kg] 1.4 [0,64]

NOTES:

- [1] Single width unit.
- [2] Per OEM specification.
- [3] Consult Certificate of Conformance PS024.



All specifications are at room temperature unless otherwise specified.

ICP® is a registered trademark of PCB Group, Inc.

In the interest of constant product improvement, we reserve the right to change specifications without notice.

Drawn:	Engineer:	Sales:	Approved:	Spec Number:
Date: 1-6-06	Date: 1/20/06	Date: 1/20/06	Date: 1/24/06	7939



3425 Walden Avenue, Depew, NY 14043

716-684-0001 Fax (716) 684-0987

E-Mail: electronics@pcb.com



Model 441A33

3-slot chassis with computer control (for Series 440 modules)

Installation and Operating Manual

**For assistance with the operation of this product,
contact PCB Piezotronics, Inc.**

**Toll-free: 800-828-8840
24-hour SensorLine: 716-684-0001
Fax: 716-684-0987
E-mail: info@pcb.com
Web: www.pcb.com**



Repair and Maintenance

PCB guarantees Total Customer Satisfaction through its “Lifetime Warranty Plus” on all Platinum Stock Products sold by PCB and through its limited warranties on all other PCB Stock, Standard and Special products. Due to the sophisticated nature of our sensors and associated instrumentation, **field servicing and repair is not recommended and, if attempted, will void the factory warranty.**

Beyond routine calibration and battery replacements where applicable, our products require no user maintenance. Clean electrical connectors, housings, and mounting surfaces with solutions and techniques that will not harm the material of construction. Observe caution when using liquids near devices that are not hermetically sealed. Such devices should only be wiped with a dampened cloth—never saturated or submerged.

In the event that equipment becomes damaged or ceases to operate, our Application Engineers are here to support your troubleshooting efforts 24 hours a day, 7 days a week. Call or email with model and serial number as well as a brief description of the problem.

Calibration

Routine calibration of sensors and associated instrumentation is necessary to maintain measurement accuracy. We recommend calibrating on an annual basis, after exposure to any extreme environmental influence, or prior to any critical test.

PCB Piezotronics is an ISO-9001 certified company whose calibration services are accredited by A2LA to ISO/IEC 17025, with full traceability to SI through N.I.S.T. In addition to our standard calibration services, we also offer specialized tests, including: sensitivity at elevated or cryogenic temperatures, phase response, extended high or low frequency response, extended range, leak testing, hydrostatic pressure testing, and others. For more information, contact your local PCB Piezotronics distributor, sales representative, or factory customer service representative.

Returning Equipment

If factory repair is required, our representatives will provide you with a Return Material Authorization (RMA) number, which we use to reference any information you have already provided and expedite the repair process. This number should be clearly marked on the outside of all returned package(s) and on any packing list(s) accompanying the shipment.

Contact Information

PCB Piezotronics, Inc.
3425 Walden Ave.
Depew, NY14043 USA
Toll-free: (800) 828-8840
24-hour SensorLine: (716) 684-0001
General inquiries: info@pcb.com
Repair inquiries: rma@pcb.com

For a complete list of distributors, global offices and sales representatives, visit our website, www.pcb.com.

Safety Considerations

This product is intended for use by qualified personnel who recognize shock hazards and are familiar with the precautions required to avoid injury. While our equipment is designed with user safety in mind, the protection provided by the equipment may be impaired if equipment is used in a manner not specified by this manual.

Discontinue use and contact our 24-Hour Sensorline if:

- Assistance is needed to safely operate equipment
- Damage is visible or suspected
- Equipment fails or malfunctions

For complete equipment ratings, refer to the enclosed specification sheet for your product.

Definition of Terms and Symbols

The following symbols may be used in this manual:



DANGER

Indicates an immediate hazardous situation, which, if not avoided, may result in death or serious injury.

**CAUTION**

Refers to hazards that could damage the instrument.

**NOTE**

Indicates tips, recommendations and important information. The notes simplify processes and contain additional information on particular operating steps.

The following symbols may be found on the equipment described in this manual:



This symbol on the unit indicates that high voltage may be present. Use standard safety precautions to avoid personal contact with this voltage.



This symbol on the unit indicates that the user should refer to the operating instructions located in the manual.



This symbol indicates safety, earth ground.



PCB工业监视和测量设备 - 中国RoHS2公布表

PCB Industrial Monitoring and Measuring Equipment - China RoHS 2 Disclosure Table

部件名称	有害物质					
	铅 (Pb)	汞 (Hg)	镉 (Cd)	六价铬 (Cr(VI))	多溴联苯 (PBB)	多溴二苯醚 (PBDE)
住房	0	0	0	0	0	0
PCB板	X	0	0	0	0	0
电气连接器	0	0	0	0	0	0
压电晶体	X	0	0	0	0	0
环氧	0	0	0	0	0	0
铁氟龙	0	0	0	0	0	0
电子	0	0	0	0	0	0
厚膜基板	0	0	X	0	0	0
电线	0	0	0	0	0	0
电缆	X	0	0	0	0	0
塑料	0	0	0	0	0	0
焊接	X	0	0	0	0	0
铜合金/黄铜	X	0	0	0	0	0
本表格依据 SJ/T 11364 的规定编制。						
0：表示该有害物质在该部件所有均质材料中的含量均在 GB/T 26572 规定的限量要求以下。						
X：表示该有害物质至少在该部件的某一均质材料中的含量超出 GB/T 26572 规定的限量要求。						
铅是欧洲RoHS指令2011/65/ EU附件三和附件四目前由于允许的豁免。						

CHINA RoHS COMPLIANCE

Component Name	Hazardous Substances					
	Lead (Pb)	Mercury (Hg)	Cadmium (Cd)	Chromium VI Compounds (Cr(VI))	Polybrominated Biphenyls (PBB)	Polybrominated Diphenyl Ethers (PBDE)
Housing	O	O	O	O	O	O
PCB Board	X	O	O	O	O	O
Electrical Connectors	O	O	O	O	O	O
Piezoelectric Crystals	X	O	O	O	O	O
Epoxy	O	O	O	O	O	O
Teflon	O	O	O	O	O	O
Electronics	O	O	O	O	O	O
Thick Film Substrate	O	O	X	O	O	O
Wires	O	O	O	O	O	O
Cables	X	O	O	O	O	O
Plastic	O	O	O	O	O	O
Solder	X	O	O	O	O	O
Copper Alloy/Brass	X	O	O	O	O	O

This table is prepared in accordance with the provisions of SJ/T 11364.

O: Indicates that said hazardous substance contained in all of the homogeneous materials for this part is below the limit requirement of GB/T 26572.

X: Indicates that said hazardous substance contained in at least one of the homogeneous materials for this part is above the limit requirement of GB/T 26572.

Lead is present due to allowed exemption in Annex III or Annex IV of the European RoHS Directive 2011/65/EU.

APPLICATION	USED ON	VAR	PCB Piezotronics Inc. claims proprietary rights in the information disclosed hereon. Neither it nor any reproduction thereof will be disclosed to others without written consent of PCB Piezotronics Inc.
NEXT ASSY			

REVISIONS			
ZONE	REV	DESCRIPTION	APP'D

11929

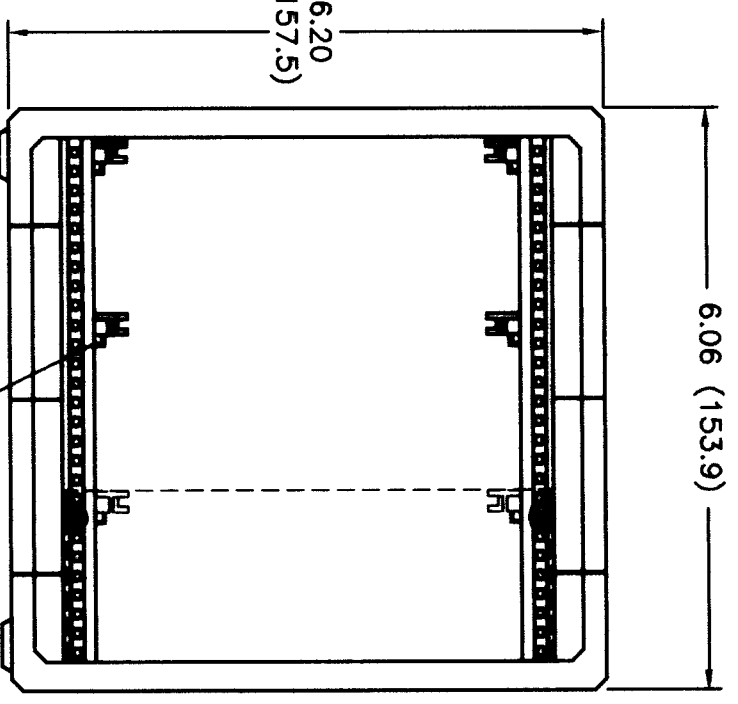

RAIL-SLOTS FOR CARD MODULES

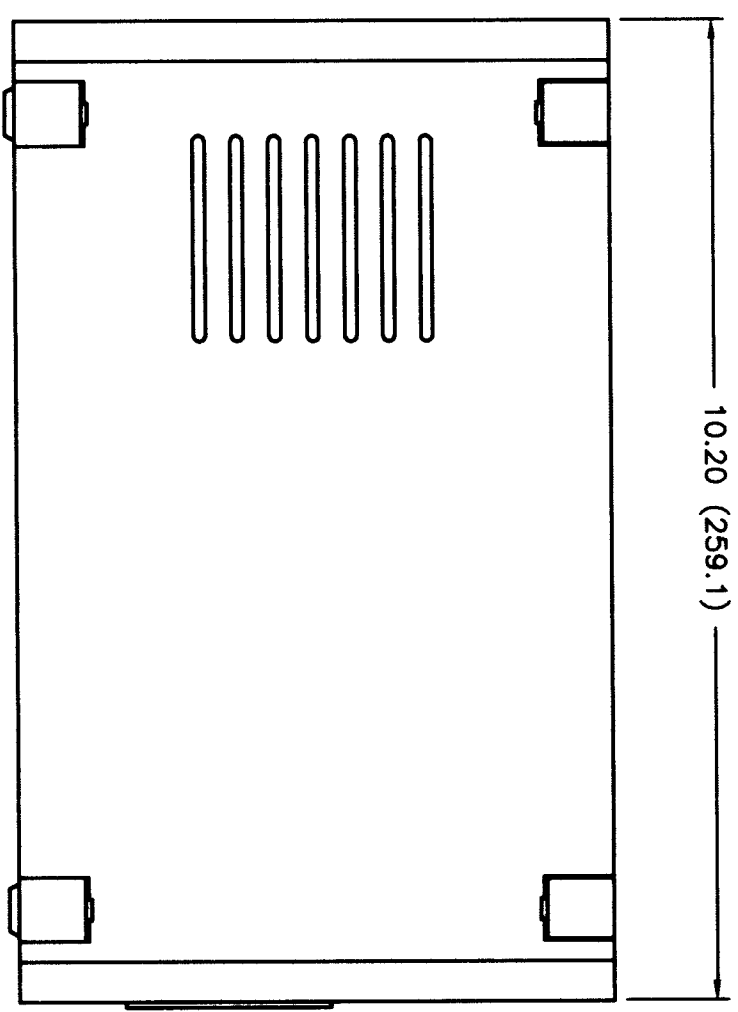

AC RECEPTACLE

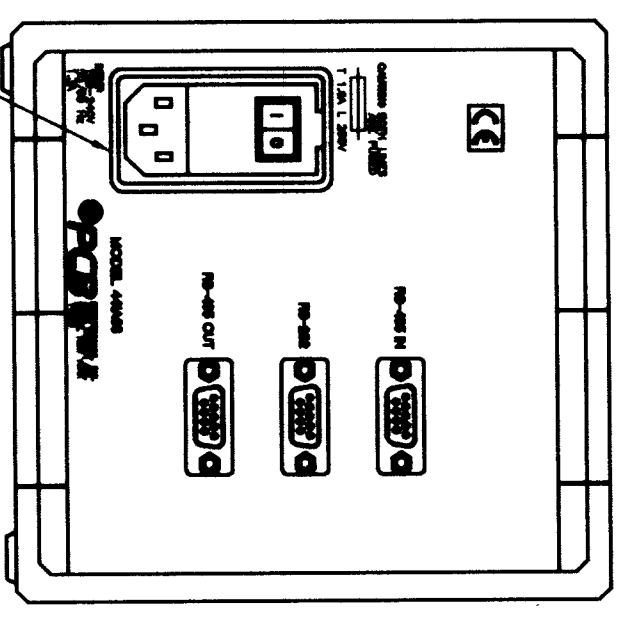

UNLESS SPECIFIED TOLERANCES	
DIMENSIONS IN INCHES	DIMENSIONS IN MILLIMETERS
DECIMALS XX ±.01	DECIMALS XX ±0.3
XXX ±.006	XXX ±0.13
ANGLES ±2 DEGREES	ANGLES ±2 DEGREES
FILLETS AND RADIUS .003 - .006	FILLETS AND RADIUS (0.07 - 0.13)

DRAWN	BY	NO.	DATE	MFG	DATE
CHK'D	BY	NO.	DATE	ENGR	DATE
APP'D	BY	NO.	DATE		

3 SLOT SYSTEM CHASSIS
 MODEL 441A33
 OUTLINE DRAWING
 TITLE

SCALE: 2=1 SHEET 1 OF 1

PCB PIEZOTRONICS
 3403 WILDEN AVE. DEPT. 1140A3
 (716) 664-0001 EMAIL: SALES@PCB.COM

11929



Model 443B02

MODULAR AC LINE POWER SUPPLY

Installation and Operating Manual

This manual contains the 441A101, 441A33, 443B102 installation and operating manuals that comprise a Model 443B02 MODULAR AC LINE POWER SUPPLY kit.

**For assistance with the operation of this product,
contact the PCB Piezotronics, Inc.**

Toll-free: 716-684-0001

24-hour SensorLine: 716-684-0001

Fax: 716-684-0987

E-mail: info@pcb.com

Web: www.pcb.com



Repair and Maintenance

PCB guarantees Total Customer Satisfaction through its “Lifetime Warranty Plus” on all Platinum Stock Products sold by PCB and through its limited warranties on all other PCB Stock, Standard and Special products. Due to the sophisticated nature of our sensors and associated instrumentation, **field servicing and repair is not recommended and, if attempted, will void the factory warranty.**

Beyond routine calibration and battery replacements where applicable, our products require no user maintenance. Clean electrical connectors, housings, and mounting surfaces with solutions and techniques that will not harm the material of construction. Observe caution when using liquids near devices that are not hermetically sealed. Such devices should only be wiped with a dampened cloth—never saturated or submerged.

In the event that equipment becomes damaged or ceases to operate, our Application Engineers are here to support your troubleshooting efforts 24 hours a day, 7 days a week. Call or email with model and serial number as well as a brief description of the problem.

Calibration

Routine calibration of sensors and associated instrumentation is necessary to maintain measurement accuracy. We recommend calibrating on an annual basis, after exposure to any extreme environmental influence, or prior to any critical test.

PCB Piezotronics is an ISO-9001 certified company whose calibration services are accredited by A2LA to ISO/IEC 17025, with full traceability to SI through N.I.S.T. In addition to our standard calibration services, we also offer specialized tests, including: sensitivity at elevated or cryogenic temperatures, phase response, extended high or low frequency response, extended range, leak testing, hydrostatic pressure testing, and others. For more information, contact your local PCB Piezotronics distributor, sales representative, or factory customer service representative.

Returning Equipment

If factory repair is required, our representatives will provide you with a Return Material Authorization (RMA) number, which we use to reference any information you have already provided and expedite the repair process. This number should be clearly marked on the outside of all returned package(s) and on any packing list(s) accompanying the shipment.

Contact Information

PCB Piezotronics, Inc.
3425 Walden Ave.
Depew, NY14043 USA
Toll-free: (800) 828-8840
24-hour SensorLine: (716) 684-0001
General inquiries: info@pcb.com
Repair inquiries: rma@pcb.com

For a complete list of distributors, global offices and sales representatives, visit our website, www.pcb.com.

Safety Considerations

This product is intended for use by qualified personnel who recognize shock hazards and are familiar with the precautions required to avoid injury. While our equipment is designed with user safety in mind, the protection provided by the equipment may be impaired if equipment is used in a manner not specified by this manual.

Discontinue use and contact our 24-Hour Sensorline if:

- Assistance is needed to safely operate equipment
- Damage is visible or suspected
- Equipment fails or malfunctions

For complete equipment ratings, refer to the enclosed specification sheet for your product.

Definition of Terms and Symbols

The following symbols may be used in this manual:



DANGER

Indicates an immediate hazardous situation, which, if not avoided, may result in death or serious injury.

**CAUTION**

Refers to hazards that could damage the instrument.

**NOTE**

Indicates tips, recommendations and important information. The notes simplify processes and contain additional information on particular operating steps.

The following symbols may be found on the equipment described in this manual:



This symbol on the unit indicates that high voltage may be present. Use standard safety precautions to avoid personal contact with this voltage.



This symbol on the unit indicates that the user should refer to the operating instructions located in the manual.



This symbol indicates safety, earth ground.



PCB工业监视和测量设备 - 中国RoHS2公布表

PCB Industrial Monitoring and Measuring Equipment - China RoHS 2 Disclosure Table

部件名称	有害物质					
	铅 (Pb)	汞 (Hg)	镉 (Cd)	六价铬 (Cr(VI))	多溴联苯 (PBB)	多溴二苯醚 (PBDE)
住房	0	0	0	0	0	0
PCB板	X	0	0	0	0	0
电气连接器	0	0	0	0	0	0
压电晶体	X	0	0	0	0	0
环氧	0	0	0	0	0	0
铁氟龙	0	0	0	0	0	0
电子	0	0	0	0	0	0
厚膜基板	0	0	X	0	0	0
电线	0	0	0	0	0	0
电缆	X	0	0	0	0	0
塑料	0	0	0	0	0	0
焊接	X	0	0	0	0	0
铜合金/黄铜	X	0	0	0	0	0
本表格依据 SJ/T 11364 的规定编制。						
0：表示该有害物质在该部件所有均质材料中的含量均在 GB/T 26572 规定的限量要求以下。						
X：表示该有害物质至少在该部件的某一均质材料中的含量超出 GB/T 26572 规定的限量要求。						
铅是欧洲RoHS指令2011/65/ EU附件三和附件四目前由于允许的豁免。						

CHINA RoHS COMPLIANCE

Component Name	Hazardous Substances					
	Lead (Pb)	Mercury (Hg)	Cadmium (Cd)	Chromium VI Compounds (Cr(VI))	Polybrominated Biphenyls (PBB)	Polybrominated Diphenyl Ethers (PBDE)
Housing	O	O	O	O	O	O
PCB Board	X	O	O	O	O	O
Electrical Connectors	O	O	O	O	O	O
Piezoelectric Crystals	X	O	O	O	O	O
Epoxy	O	O	O	O	O	O
Teflon	O	O	O	O	O	O
Electronics	O	O	O	O	O	O
Thick Film Substrate	O	O	X	O	O	O
Wires	O	O	O	O	O	O
Cables	X	O	O	O	O	O
Plastic	O	O	O	O	O	O
Solder	X	O	O	O	O	O
Copper Alloy/Brass	X	O	O	O	O	O

This table is prepared in accordance with the provisions of SJ/T 11364.

O: Indicates that said hazardous substance contained in all of the homogeneous materials for this part is below the limit requirement of GB/T 26572.

X: Indicates that said hazardous substance contained in at least one of the homogeneous materials for this part is above the limit requirement of GB/T 26572.

Lead is present due to allowed exemption in Annex III or Annex IV of the European RoHS Directive 2011/65/EU.

PCB Piezotronics Inc. claims proprietary rights in the information disclosed hereon. Neither it nor any reproduction thereof will be disclosed to others without the written consent of PCB Piezotronics Inc.

14513

REVISIONS

REV	DESCRIPTION	DIN
A	UPDATE TO NEW HANDLE AND LEXAN	51414

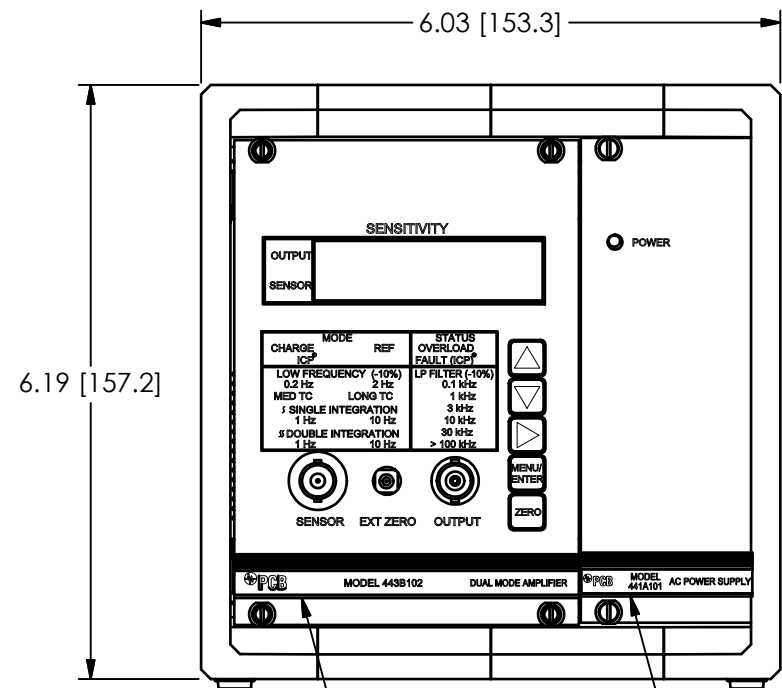

DUAL MODEL VIBRATION AMPLIFIER MODULE
MODEL 443B102

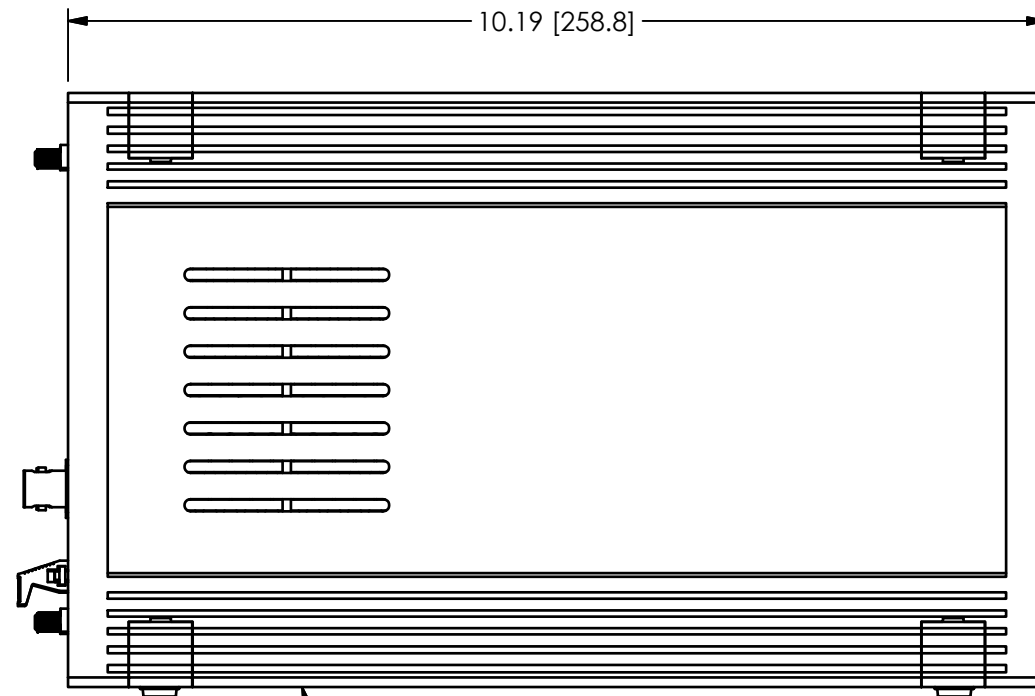

MODULE ENCLOSURE
MODEL 441A33

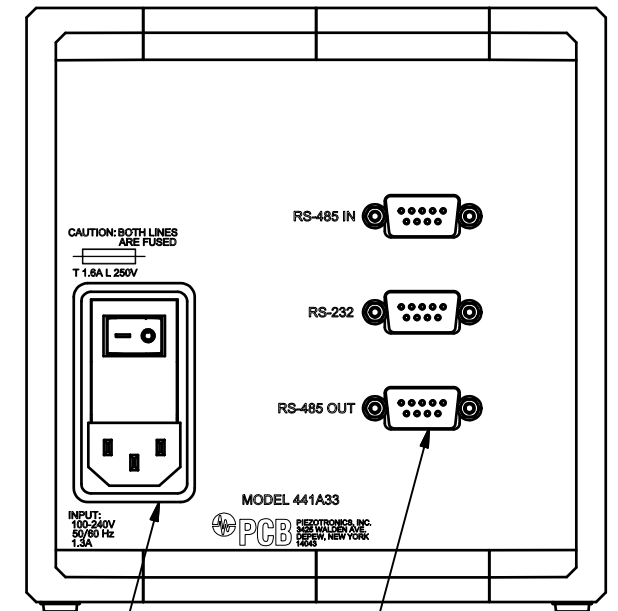

AC RECEPTACLE
SERIAL COMMUNICATION CONNECTORS

AC POWER SUPPLY MODULE
MODEL 441A101

UNLESS OTHERWISE SPECIFIED TOLERANCES ARE:		DRAWN		CHECKED		ENGINEER		PCB PIEZOTRONICS AN AMPHENOL COMPANY 3425 WALDEN AVE. DEPEW, NY 14043 (716) 684-0001 E-MAIL: sales@pcb.com
DIMENSIONS IN INCHES	DIMENSIONS IN MILLIMETERS [IN BRACKETS]	KSR	8/26/21	KSR	8/26/21	CPH	8/26/21	
DECIMALS XX ±.03 XXX ±.010 ANGLES ± 2 DEGREES	DECIMALS X ± 0.8 XX ± 0.25 ANGLES ± 2 DEGREES	TITLE OUTLINE DRAWING MODEL 443B02						DWG. NO. 14513
CABLE TOLERANCES IN ENGLISH 1" ≤ LENGTH < 1' = +1' / - 0 1' ≤ LENGTH < 5' = +2' / - 0 5' ≤ LENGTH < 100' = +6' / - 0 100' ≤ LENGTH = +1' / - 0	CABLE TOLERANCES IN METRIC 2.54cm ≤ LENGTH < 30.5cm = +2.54cm / - 0 30.5cm ≤ LENGTH < 1.5m = +5.1cm / - 0 1.5m ≤ LENGTH < 30.5m = +15.2cm / - 0 30.5m ≤ LENGTH = +30.5cm / - 0							SCALE: .5X
FILLETS AND RADII .003 - .005	FILLETS AND RADII 0.07 - 0.13							



Model 443B102
Dual Mode Modular Signal Conditioner Card
Installation and Operating Manual

**For assistance with the operation of this product,
contact PCB Piezotronics, Inc.**

Toll-free: 800-828-8840
24-hour SensorLine: 716-684-0001
Fax: 716-684-0987
E-mail: info@pcb.com
Web: www.pcb.com



Repair and Maintenance

PCB guarantees Total Customer Satisfaction through its “Lifetime Warranty Plus” on all Platinum Stock Products sold by PCB and through its limited warranties on all other PCB Stock, Standard and Special products. Due to the sophisticated nature of our sensors and associated instrumentation, **field servicing and repair is not recommended and, if attempted, will void the factory warranty.**

Beyond routine calibration and battery replacements where applicable, our products require no user maintenance. Clean electrical connectors, housings, and mounting surfaces with solutions and techniques that will not harm the material of construction. Observe caution when using liquids near devices that are not hermetically sealed. Such devices should only be wiped with a dampened cloth—never saturated or submerged.

In the event that equipment becomes damaged or ceases to operate, our Application Engineers are here to support your troubleshooting efforts 24 hours a day, 7 days a week. Call or email with model and serial number as well as a brief description of the problem.

Calibration

Routine calibration of sensors and associated instrumentation is necessary to maintain measurement accuracy. We recommend calibrating on an annual basis, after exposure to any extreme environmental influence, or prior to any critical test.

PCB Piezotronics is an ISO-9001 certified company whose calibration services are accredited by A2LA to ISO/IEC 17025, with full traceability to SI through N.I.S.T. In addition to our standard calibration services, we also offer specialized tests, including: sensitivity at elevated or cryogenic temperatures, phase response, extended high or low frequency response, extended range, leak testing, hydrostatic pressure testing, and others. For more information, contact your local PCB Piezotronics distributor, sales representative, or factory customer service representative.

Returning Equipment

If factory repair is required, our representatives will provide you with a Return Material Authorization (RMA) number, which we use to reference any information you have already provided and expedite the repair process. This number should be clearly marked on the outside of all returned package(s) and on any packing list(s) accompanying the shipment.

Contact Information

PCB Piezotronics, Inc.
3425 Walden Ave.
Depew, NY14043 USA
Toll-free: (800) 828-8840
24-hour SensorLine: (716) 684-0001
General inquiries: info@pcb.com
Repair inquiries: rma@pcb.com

For a complete list of distributors, global offices and sales representatives, visit our website, www.pcb.com.

Safety Considerations

This product is intended for use by qualified personnel who recognize shock hazards and are familiar with the precautions required to avoid injury. While our equipment is designed with user safety in mind, the protection provided by the equipment may be impaired if equipment is used in a manner not specified by this manual.

Discontinue use and contact our 24-Hour Sensorline if:

- Assistance is needed to safely operate equipment
- Damage is visible or suspected
- Equipment fails or malfunctions

For complete equipment ratings, refer to the enclosed specification sheet for your product.

Definition of Terms and Symbols

The following symbols may be used in this manual:



DANGER

Indicates an immediate hazardous situation, which, if not avoided, may result in death or serious injury.

**CAUTION**

Refers to hazards that could damage the instrument.

**NOTE**

Indicates tips, recommendations and important information. The notes simplify processes and contain additional information on particular operating steps.

The following symbols may be found on the equipment described in this manual:



This symbol on the unit indicates that high voltage may be present. Use standard safety precautions to avoid personal contact with this voltage.



This symbol on the unit indicates that the user should refer to the operating instructions located in the manual.



This symbol indicates safety, earth ground.



PCB工业监视和测量设备 - 中国RoHS2公布表

PCB Industrial Monitoring and Measuring Equipment - China RoHS 2 Disclosure Table

部件名称	有害物质					
	铅 (Pb)	汞 (Hg)	镉 (Cd)	六价铬 (Cr(VI))	多溴联苯 (PBB)	多溴二苯醚 (PBDE)
住房	0	0	0	0	0	0
PCB板	X	0	0	0	0	0
电气连接器	0	0	0	0	0	0
压电晶体	X	0	0	0	0	0
环氧	0	0	0	0	0	0
铁氟龙	0	0	0	0	0	0
电子	0	0	0	0	0	0
厚膜基板	0	0	X	0	0	0
电线	0	0	0	0	0	0
电缆	X	0	0	0	0	0
塑料	0	0	0	0	0	0
焊接	X	0	0	0	0	0
铜合金/黄铜	X	0	0	0	0	0
本表格依据 SJ/T 11364 的规定编制。						
0：表示该有害物质在该部件所有均质材料中的含量均在 GB/T 26572 规定的限量要求以下。						
X：表示该有害物质至少在该部件的某一均质材料中的含量超出 GB/T 26572 规定的限量要求。						
铅是欧洲RoHS指令2011/65/ EU附件三和附件四目前由于允许的豁免。						

CHINA RoHS COMPLIANCE

Component Name	Hazardous Substances					
	Lead (Pb)	Mercury (Hg)	Cadmium (Cd)	Chromium VI Compounds (Cr(VI))	Polybrominated Biphenyls (PBB)	Polybrominated Diphenyl Ethers (PBDE)
Housing	O	O	O	O	O	O
PCB Board	X	O	O	O	O	O
Electrical Connectors	O	O	O	O	O	O
Piezoelectric Crystals	X	O	O	O	O	O
Epoxy	O	O	O	O	O	O
Teflon	O	O	O	O	O	O
Electronics	O	O	O	O	O	O
Thick Film Substrate	O	O	X	O	O	O
Wires	O	O	O	O	O	O
Cables	X	O	O	O	O	O
Plastic	O	O	O	O	O	O
Solder	X	O	O	O	O	O
Copper Alloy/Brass	X	O	O	O	O	O

This table is prepared in accordance with the provisions of SJ/T 11364.

O: Indicates that said hazardous substance contained in all of the homogeneous materials for this part is below the limit requirement of GB/T 26572.

X: Indicates that said hazardous substance contained in at least one of the homogeneous materials for this part is above the limit requirement of GB/T 26572.

Lead is present due to allowed exemption in Annex III or Annex IV of the European RoHS Directive 2011/65/EU.

PCB Piezotronics Inc. claims proprietary rights in the information disclosed hereon. Neither it nor any reproduction thereof will be disclosed to others without the written consent of PCB Piezotronics Inc.

14513

REVISIONS

REV	DESCRIPTION	DIN
A	UPDATE TO NEW HANDLE AND LEXAN	51414

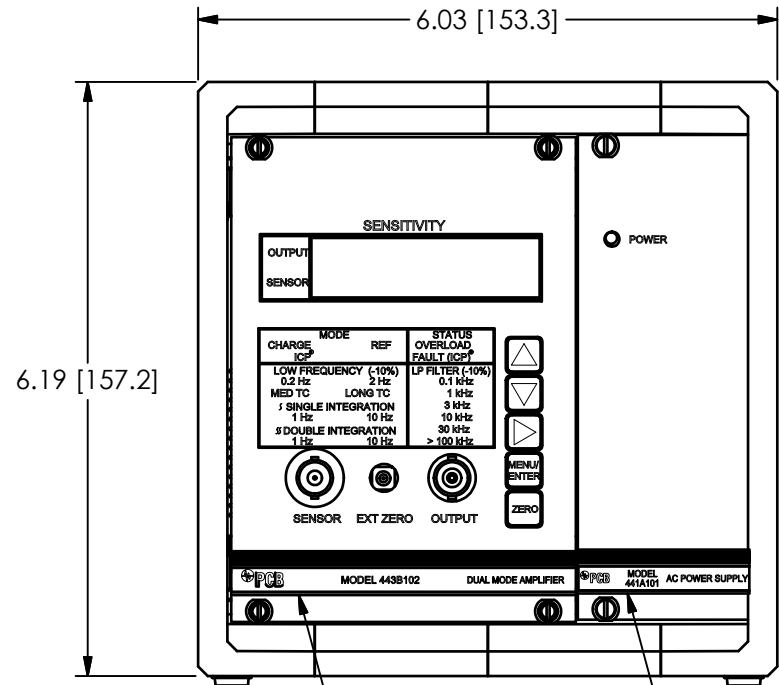

DUAL MODEL VIBRATION AMPLIFIER MODULE
MODEL 443B102

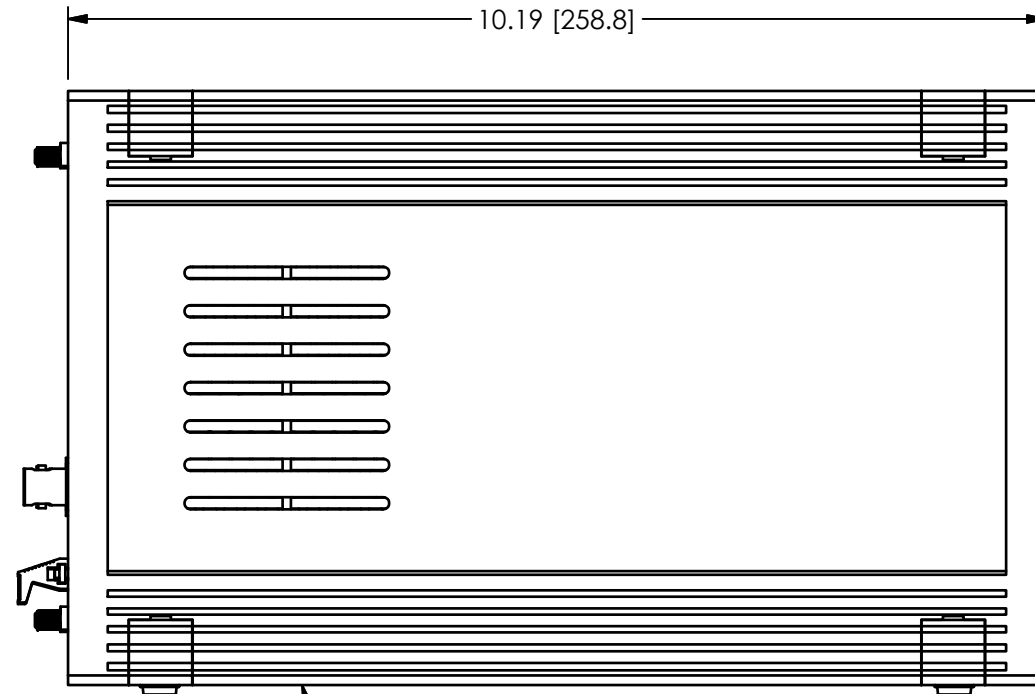

MODULE ENCLOSURE
MODEL 441A33

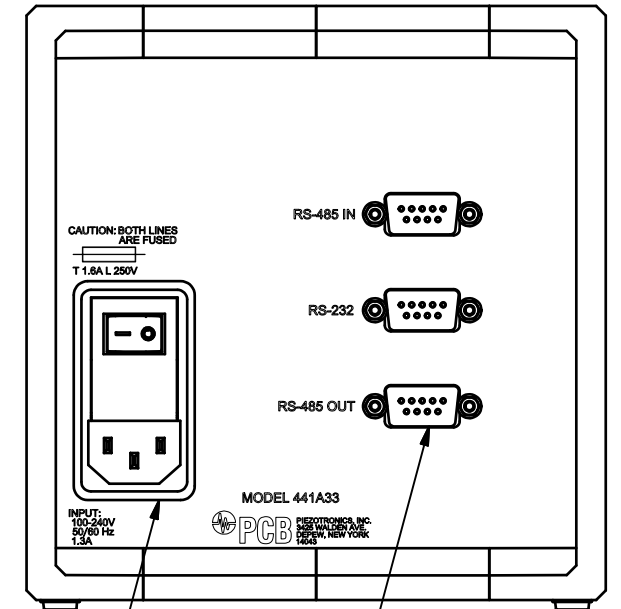

AC RECEPTACLE

SERIAL COMMUNICATION
CONNECTORS

AC POWER SUPPLY MODULE
MODEL 441A101

UNLESS OTHERWISE SPECIFIED TOLERANCES ARE:		DRAWN	CHECKED	ENGINEER
DIMENSIONS IN INCHES	DIMENSIONS IN MILLIMETERS [IN BRACKETS]	KSR	8/26/21	KSR
DECIMALS XX ±.03	DECIMALS X ±0.8			CPH
XXX ±.010	XX ±0.25	TITLE		
ANGLES ± 2 DEGREES	ANGLES ± 2 DEGREES	OUTLINE DRAWING		
CABLE TOLERANCES IN ENGLISH	CABLE TOLERANCES IN METRIC	MODEL 443B02		
1"≤ LENGTH < 1' = +1/- 0	2.54cm ≤ LENGTH < 30.5cm = +2.54cm/ - 0			
1'≤ LENGTH < 5' = +2/- 0	30.5cm ≤ LENGTH < 1.5m = +5.1cm/ - 0			
5'≤ LENGTH < 100' = +6/- 0	1.5m ≤ LENGTH < 30.5m = +15.2cm/ - 0			
100'≤ LENGTH = +1/- 0	30.5m ≤ LENGTH = +30.5cm/ - 0			
FILLETS AND RADII .003 - .005	FILLETS AND RADII 0.07 - 0.13			

PCB PIEZOTRONICS
AN AMPHENOL COMPANY

3425 WALDEN AVE. DEPEW, NY 14043
(716) 684-0001 E-MAIL: sales@pcb.com

CODE IDENT. NO. 52681
DWG. NO. 14513

SCALE: .5X SHEET 1 OF 1