



Model 740M04
Uniaxial ICP® Strain Sensor
Installation and Operating Manual

**For assistance with the operation of this product,
contact PCB Piezotronics, Inc.**

Toll-free: 800-828-8840
24-hour SensorLine: 716-684-0001
Fax: 716-684-0987
E-mail: info@pcb.com
Web: www.pcb.com



Repair and Maintenance

PCB guarantees Total Customer Satisfaction through its “Lifetime Warranty Plus” on all Platinum Stock Products sold by PCB and through its limited warranties on all other PCB Stock, Standard and Special products. Due to the sophisticated nature of our sensors and associated instrumentation, **field servicing and repair is not recommended and, if attempted, will void the factory warranty.**

Beyond routine calibration and battery replacements where applicable, our products require no user maintenance. Clean electrical connectors, housings, and mounting surfaces with solutions and techniques that will not harm the material of construction. Observe caution when using liquids near devices that are not hermetically sealed. Such devices should only be wiped with a dampened cloth—never saturated or submerged.

In the event that equipment becomes damaged or ceases to operate, our Application Engineers are here to support your troubleshooting efforts 24 hours a day, 7 days a week. Call or email with model and serial number as well as a brief description of the problem.

Calibration

Routine calibration of sensors and associated instrumentation is necessary to maintain measurement accuracy. We recommend calibrating on an annual basis, after exposure to any extreme environmental influence, or prior to any critical test.

PCB Piezotronics is an ISO-9001 certified company whose calibration services are accredited by A2LA to ISO/IEC 17025, with full traceability to SI through N.I.S.T. In addition to our standard calibration services, we also offer specialized tests, including: sensitivity at elevated or cryogenic temperatures, phase response, extended high or low frequency response, extended range, leak testing, hydrostatic pressure testing, and others. For more information, contact your local PCB Piezotronics distributor, sales representative, or factory customer service representative.

Returning Equipment

If factory repair is required, our representatives will provide you with a Return Material Authorization (RMA) number, which we use to reference any information you have already provided and expedite the repair process. This number should be clearly marked on the outside of all returned package(s) and on any packing list(s) accompanying the shipment.

Contact Information

PCB Piezotronics, Inc.
3425 Walden Ave.
Depew, NY14043 USA
Toll-free: (800) 828-8840
24-hour SensorLine: (716) 684-0001
General inquiries: info@pcb.com
Repair inquiries: rma@pcb.com

For a complete list of distributors, global offices and sales representatives, visit our website, www.pcb.com.

Safety Considerations

This product is intended for use by qualified personnel who recognize shock hazards and are familiar with the precautions required to avoid injury. While our equipment is designed with user safety in mind, the protection provided by the equipment may be impaired if equipment is used in a manner not specified by this manual.

Discontinue use and contact our 24-Hour Sensorline if:

- Assistance is needed to safely operate equipment
- Damage is visible or suspected
- Equipment fails or malfunctions

For complete equipment ratings, refer to the enclosed specification sheet for your product.

Definition of Terms and Symbols

The following symbols may be used in this manual:



DANGER

Indicates an immediate hazardous situation, which, if not avoided, may result in death or serious injury.

**CAUTION**

Refers to hazards that could damage the instrument.

**NOTE**

Indicates tips, recommendations and important information. The notes simplify processes and contain additional information on particular operating steps.

The following symbols may be found on the equipment described in this manual:



This symbol on the unit indicates that high voltage may be present. Use standard safety precautions to avoid personal contact with this voltage.



This symbol on the unit indicates that the user should refer to the operating instructions located in the manual.



This symbol indicates safety, earth ground.



PCB工业监视和测量设备 - 中国RoHS2公布表

PCB Industrial Monitoring and Measuring Equipment - China RoHS 2 Disclosure Table

部件名称	有害物质					
	铅 (Pb)	汞 (Hg)	镉 (Cd)	六价铬 (Cr(VI))	多溴联苯 (PBB)	多溴二苯醚 (PBDE)
住房	0	0	0	0	0	0
PCB板	X	0	0	0	0	0
电气连接器	0	0	0	0	0	0
压电晶体	X	0	0	0	0	0
环氧	0	0	0	0	0	0
铁氟龙	0	0	0	0	0	0
电子	0	0	0	0	0	0
厚膜基板	0	0	X	0	0	0
电线	0	0	0	0	0	0
电缆	X	0	0	0	0	0
塑料	0	0	0	0	0	0
焊接	X	0	0	0	0	0
铜合金/黄铜	X	0	0	0	0	0
本表格依据 SJ/T 11364 的规定编制。						
0：表示该有害物质在该部件所有均质材料中的含量均在 GB/T 26572 规定的限量要求以下。						
X：表示该有害物质至少在该部件的某一均质材料中的含量超出 GB/T 26572 规定的限量要求。						
铅是欧洲RoHS指令2011/65/ EU附件三和附件四目前由于允许的豁免。						

CHINA RoHS COMPLIANCE

Component Name	Hazardous Substances					
	Lead (Pb)	Mercury (Hg)	Cadmium (Cd)	Chromium VI Compounds (Cr(VI))	Polybrominated Biphenyls (PBB)	Polybrominated Diphenyl Ethers (PBDE)
Housing	O	O	O	O	O	O
PCB Board	X	O	O	O	O	O
Electrical Connectors	O	O	O	O	O	O
Piezoelectric Crystals	X	O	O	O	O	O
Epoxy	O	O	O	O	O	O
Teflon	O	O	O	O	O	O
Electronics	O	O	O	O	O	O
Thick Film Substrate	O	O	X	O	O	O
Wires	O	O	O	O	O	O
Cables	X	O	O	O	O	O
Plastic	O	O	O	O	O	O
Solder	X	O	O	O	O	O
Copper Alloy/Brass	X	O	O	O	O	O

This table is prepared in accordance with the provisions of SJ/T 11364.

O: Indicates that said hazardous substance contained in all of the homogeneous materials for this part is below the limit requirement of GB/T 26572.

X: Indicates that said hazardous substance contained in at least one of the homogeneous materials for this part is above the limit requirement of GB/T 26572.

Lead is present due to allowed exemption in Annex III or Annex IV of the European RoHS Directive 2011/65/EU.

General OPERATING GUIDE

for use with

MODEL 740B02 PIEZOELECTRIC ICP[®] STRAIN SENSOR

SPECIFICATION SHEET, INSTALLATION DRAWING
AND CALIBRATION INFORMATION ENCLOSED

PCB ASSUMES NO RESPONSIBILITY FOR DAMAGE CAUSED TO THIS PRODUCT AS A RESULT OF PROCEDURES THAT ARE INCONSISTENT WITH THIS OPERATING GUIDE.

1.0 INTRODUCTION AND DESCRIPTION

Congratulations on the purchase of a quality PCB sensor. In order to ensure the highest level of performance for this product, it is imperative that you properly familiarize yourself with the correct mounting and installation techniques before attempting to operate this device. If, after reading this manual, you have any additional questions concerning this sensor or its application, feel free to call a Factory Application Engineer at 716-684-0001.

The Model 740B02 Strain Sensor is structured with a quartz sensing element and microelectronic circuitry in a low-profile titanium housing, making it the ideal choice for high-resolution measurements of dynamic strain. The unit is capable of measuring small strain on top of large static loads. The sensor is compatible with PCB's ICP[®] Sensor signal conditioners and is capable of driving long cables. Typical applications include: active vibration control, noise-path analysis, modal testing, use on aircraft and marine hulls, composite materials, "smart" structures, and vibrating machinery. See Figure 1.

2.0 ICP[®] STRAIN SENSOR BACKGROUND

ICP[®] is a registered trademark that uniquely describes PCB's piezoelectric sensors with built-in microelectronics. Powered by simple, low-cost, constant-current signal conditioners, these sensors are easily incorporated into high-precision, low-impedance systems having the following characteristics:

- Fixed voltage sensitivity, regardless of cable type or length.
- Low-impedance output; can be transmitted over long cables in harsh environments with virtually no loss in signal quality.
- Two-wire system: uses standard coaxial or two-wire cabling.
- High-resolution, voltage output, compatible with standard readout, recording, and other data acquisition equipment.
- Low per-channel cost; this strain sensor requires only low-cost, constant-current signal conditioners.
- Intrinsic self-test feature; checks sensor bias voltage.

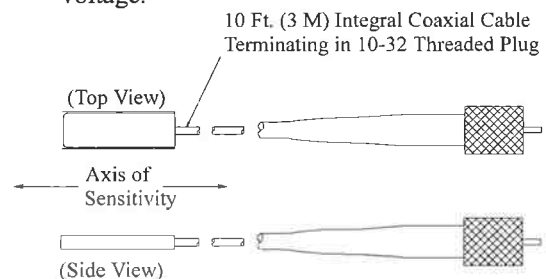

Figure 1. Model 740B02 Strain Sensor

Enclosed is a **Specification Sheet**, which lists the complete performance characteristics of the sensor.

3.0 INSTALLATION

The suggested method of mounting the Model 740B02 Strain Sensor is direct adhesive mounting with a quick-bonding gel. *Proper mounting is critical to good sensor performance.* All surfaces must be clean, dry, and free

of oils before applying adhesive. The sensor should be mounted directly on the test structure according to the following procedure:

STEP 1: Prepare a smooth, flat mounting surface. A minimum surface finish of 63 μin (0.00016 mm) generally works best.

STEP 2: Place a small portion of adhesive on the underside of the sensor. The adhesive layer must be thin and uniform. Firmly press down on the assembly to displace any extra adhesive. Be aware that excessive amounts of adhesive may affect the response of the unit.

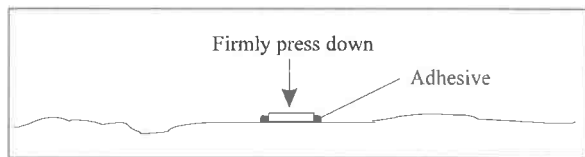

Figure 2. Typical Adhesive Mounting

4.0 REMOVAL (other than wax)

NOTE: A debonder should always be used to avoid sensor damage.

To avoid damaging the strain sensor, a debonding agent must be applied to the adhesive prior to sensor removal. With so many adhesives in use (everything from super glues, dental cement, epoxies, etc), there is no universal debonding agent available. The debonder for the Loctite 454 adhesive that PCB offers is Acetone. If you are using anything other than Loctite 454, you will have to check with the individual manufacturers for their debonding recommendations. The debonding agent must be allowed to penetrate the surface in order to properly react with the adhesive, so it is advisable to wait a few minutes before removing the sensor.

After the debonding agent has set, use the supplied removal tool and use a gentle shearing (or twisting) motion (by hand only) to remove the sensor from the test structure.

5.0 POWERING

All ICP[®] sensors require constant current excitation for proper operation. For this reason, use only PCB constant current signal conditioners or other approved constant current sources. A typical system schematic is shown hereafter.

Note: Damage to the built-in electronics resulting from the application of incorrect power or the use of an unapproved power source is NOT covered by warranty.

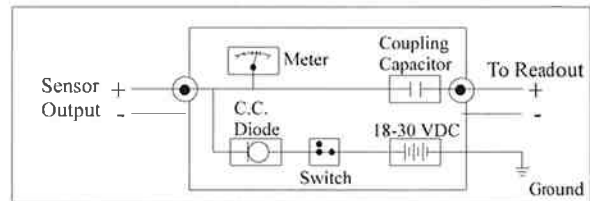

Figure 3. Typical System Schematic

The power supply consists of a well-regulated 18 to 30 VDC source. In general, battery-powered devices offer versatility for portable, low-noise measurements; line-powered units provide the capability for continuous monitoring. This voltage is regulated by a current-limiting circuit that provides the constant current excitation for proper operation of ICP[®] sensors.

Note: Under no circumstances should a voltage be supplied to an ICP[®] sensor without a current-regulating diode or equivalent electrical circuit.

Meters or LEDs are used to monitor the bias voltage on the sensor output signal to check sensor operation and detect cable faults. Normally, a “yellow” reading indicates an open circuit; “green” indicates normal operation; and “red” indicates either a short or overload condition. Finally, a capacitor at the output stage of the device removes the sensor output bias voltage from the measurement signal. This provides a zero-based, AC-coupled output compatible with most standard readout devices.

Note: “Buffered” or “DC-coupled” signal conditioners should be used on readout devices with an input impedance less than one megohm.

Today, many FFT analyzers, data acquisition modules, and data collectors incorporate constant current excitation for direct use with ICP[®] sensors. However, before using this feature, check that the supply voltage and constant current are adequate for use with your sensor.

Please contact the respective Signal Conditioner Manufacturer or check the product manual for additional information.

6.0 OPERATING

After completing the system setup, switch on the signal conditioner and allow 1 or 2 minutes for the system to stabilize. After this time, the meter (or LED) on the signal conditioner should be reading "green." This indicates proper operation and you are ready to begin taking measurements. If a faulty condition is monitored, first check all system connections and then check the functionality of the cable and signal conditioner. If this system still does not operate properly, feel free to consult a PCB Applications Engineer.

Note: Always operate the sensor within the limitations listed on the enclosed *Specification Sheet*. Operating the device outside these parameters can cause temporary or perhaps even permanent damage to the sensor.

7.0 FREQUENCY RESPONSE

The upper limit to the frequency response is determined either by cable drive considerations or by wavelength of dynamic strain.

Long cables capacitively load the sensor output. Long cables and measurement of high frequency may require the use of a higher current (>2 mA) power supply. For more information on long cable driving, see the appropriate section in the Vibration Division's Sensor Catalog. For short cable lengths (<10 ft [3 m]), a 2 mA constant-current supply is usually sufficient for a frequency range up to 100 kHz.

Measurements are accurate when the wavelength is large compared to the length of the sensor. Wavelength can be determined from the following formula:

$$\lambda = c / f$$

Where c is the speed of sound and f is the frequency.

A good rule of thumb is that the wavelength should be ten times the length of the sensor. The upper frequency limit can be determined from the following equation:

$$f_u = 0.1c / L$$

L is the length of the sensor. The table below provides the speed of sound for various materials, the wavelength at 100,000 Hz, and the upper frequency limit for a one cm-long piezoelectric strain sensor.

Material	c (m/s)	Wavelength @ 100 kHz (cm)	Freq. limit for 1 cm - long strain sensor
Titanium	5068 m/s	5.1 cm	51 kHz
Aluminum	5040 m/s	5.0 cm	50 kHz
Steel	5140 m/s	5.1 cm	51 kHz
Plexiglass	2600 m/s	2.6 cm	26 kHz
Beryllium	12870 m/s	129 cm	129 kHz

8.0 SENSITIVITY

The strain sensor sensitivity is calibrated by the method shown in the figure below. The sensor under calibration is attached to the base of a steel cantilever beam and sensor output is compared to a precision resistive strain gage reference sensor.

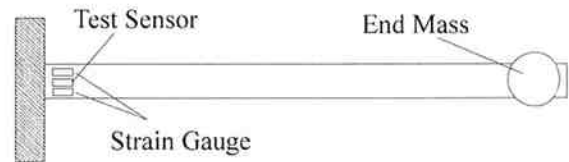

Figure 4. Calibration of Strain Sensor

The steel cantilever, with end mass, measures 26 x 2 x 0.25 inches (66.04 x 5.08 x 0.635 centimeters). The frequency is 5.7 Hz. When the stiffness modulus of the structure under test is less than the modulus of steel, the actual sensitivity is less than the calibrated sensitivity. The following table compares the Model 740B02 sensitivity when attached to a steel, aluminum, or acrylic beam.

Cantilever Beam Material	Young's Modulus (psi)	Sensitivity (mV/ $\mu\epsilon$)
Steel	30×10^6	50
Aluminum	10×10^6	41
Acrylic	0.4×10^6	5

9.0 REPAIR/SERVICE

Because of the delicate nature of most PCB instrumentation, field repair is typically NOT recommended and may void any warranty. Before returning equipment for repair, it is strongly suggested that the user confer with a factory application engineer (or local sales contact) concerning the difficulty, to ascertain if an on-site procedure may rectify the problem. If factory service is required, return the instrument according to the **RETURN PROCEDURE**

below. A quotation is provided prior to servicing at no additional charge.

10.0 RETURN PROCEDURE

To expedite the repair process, contact a PCB Customer Service Representative for a **RETURN MATERIAL AUTHORIZATION (RMA)** number prior to sending equipment to the factory. Please have information available such as model and serial number. Also, to insure efficient service, be sure to include a written description of the symptoms and problems with the equipment to your local sales contact, or contact PCB if none are located in your area. Customers outside the U.S. should consult their local PCB sales contact for information on returning equipment. For exceptions, please contact the International Sales department at PCB to request shipping instructions and an RMA. For assistance, please call (716) 684-0001, or fax us at (716) 684-0987. You may also receive assistance via e-mail at sales@pcb.com or visit our web site at www.pcb.com.

11.0 CUSTOMER SERVICE/WARRANTY

The employees of PCB strive to provide superior, unmatched customer service. Should you at any time find yourself dissatisfied with any PCB product for any reason, consult a PCB application engineer to discuss repair, refund, or exchange procedures.

PCB instrumentation is warranted against defective material and workmanship for one year unless otherwise expressly specified. Damage to instruments caused by

incorrect power or misapplication is not covered by warranty. If there is any question regarding power, intended application or general usage, please consult with your local sales contact or distributor. Batteries and other expendable hardware items are not covered by warranty.

When unexpected measurement problems arise, call our 24-hour SensorLineSM to discuss your immediate measurement instrumentation needs with a Factory Representative. Dial 716-684-0001.

MANUAL NUMBER: 18294
MANUAL REVISION: A



3425 Walden Avenue, Depew, NY 14043-2495 USA **Vibration Division toll-free 888-684-0013**
24-hour SensorLineSM 716-684-0001 FAX 716-685-3886 E-mail vibration@pcb.com Website www.pcb.com

ISO 9001 CERTIFIED

© 2001 PCB Group, Inc. In the interest of constant product improvement, specifications are subject to change without notice.
PCB, and ICP are registered trademarks of PCB Group, Inc.
All other trademarks are properties of their respective owners.

	ENGLISH	SI	
Performance			
Sensitivity(± 20 %)	5 mV/με	5 mV/με	[1]
Measurement Range	900 pk με	900 pk με	
Frequency Range	0.5 to 100,000 Hz	0.5 to 100,000 Hz	[2]
Broadband Resolution(1 to 10,000 Hz)	5.0 nε	5.0 nε	[3]
Non-Linearity	≤ 1.5 %	≤ 1.5 %	[4][5]
Transverse Sensitivity	≤ 5 %	≤ 5 %	[3]
Environmental			
Overload Limit(Shock)	± 10,000 g pk	± 98,000 m/s ² pk	
Temperature Range	-65 to +250 °F	-53 to +121 °C	
Acceleration Sensitivity	0.001 με/g	0.0001 με/(m/s ²)	[3][6]
Electrical			
Excitation Voltage	20 to 30 VDC	20 to 30 VDC	
Constant Current Excitation	2 to 20 mA	2 to 20 mA	
Output Bias Voltage	8 to 14 VDC	8 to 14 VDC	
Discharge Time Constant	1 to 3 sec	1 to 3 sec	
Spectral Noise(1 Hz)	1,900 pε/√Hz	1,900 pε/√Hz	[3][7]
Spectral Noise(10 Hz)	600 pε/√Hz	600 pε/√Hz	[3]
Spectral Noise(100 Hz)	200 pε/√Hz	200 pε/√Hz	[3]
Spectral Noise(1 kHz)	60 pε/√Hz	60 pε/√Hz	[3]
Spectral Noise(10 kHz)	15 pε/√Hz	15 pε/√Hz	[3]
Physical			
Sensing Element	Quartz	Quartz	
Housing Material	Titanium	Titanium	
Sealing	Epoxy	Epoxy	
Size (Width x Length x Height)	0.2 in x 0.6 in x 0.07 in	5.1 mm x 15.2 mm x 1.8 mm	
Weight	0.02 oz	0.5 gm	[3]
Electrical Connector	10-32 Coaxial Plug	10-32 Coaxial Plug	
Mounting	Adhesive	Adhesive	
Cable Length	10 ft	10 ft	
Cable Type	030 Coaxial	030 Coaxial	

OPTIONAL VERSIONS

Optional versions have identical specifications and accessories as listed for the standard model except where noted below. More than one option may be used.

NOTES:

[1] Calibrated on a steel bar at 100 με
 [2] Based on cable drive of 100 ft at 30 pF/ft 20 mA excitation.
 [3] Typical.
 [4] Zero-based, least-squares, straight line method.
 [5] Linearity to full range can be obtained only when bond strength of epoxy mounting adhesive is suitable.
 [6] Measured perpendicular to sensing axis.
 [7] Strain level equivalent.
 [8] See PCB Declaration of Conformance PS023 for details.

SUPPLIED ACCESSORIES:

Model 039A07 Removal Tool (1)
 Model 080A90 Quick Bonding Gel (1)

Entered: RB	Engineer: JD	Sales: KK	Approved: JD	Spec Number:
Date: 11/17/2020	Date: 11/17/2020	Date: 11/17/2020	Date: 11/17/2020	4204

PCB PIEZOTRONICS
 Phone: 716-684-0001
 Fax: 716-684-0987
 E-Mail: info@pcb.com
 3425 Walden Avenue, Depew, NY 14043



All specifications are at room temperature unless otherwise specified.
 In the interest of constant product improvement, we reserve the right to change specifications without notice.
 ICP® is a registered trademark of PCB Piezotronics, Inc.

PCB Piezotronics Inc. claims proprietary rights in the information disclosed hereon. Neither it nor any reproduction thereof will be disclosed to others without written consent of PCB Piezotronics Inc.

REVISIONS

REV	DESCRIPTION	ECN	APP'D
B	UPDATED TO SHOW ETCHING	14985	DM 3/02
C	REMOVE MODEL NO. FROM CABLE	28295	MDF 3/08

9600

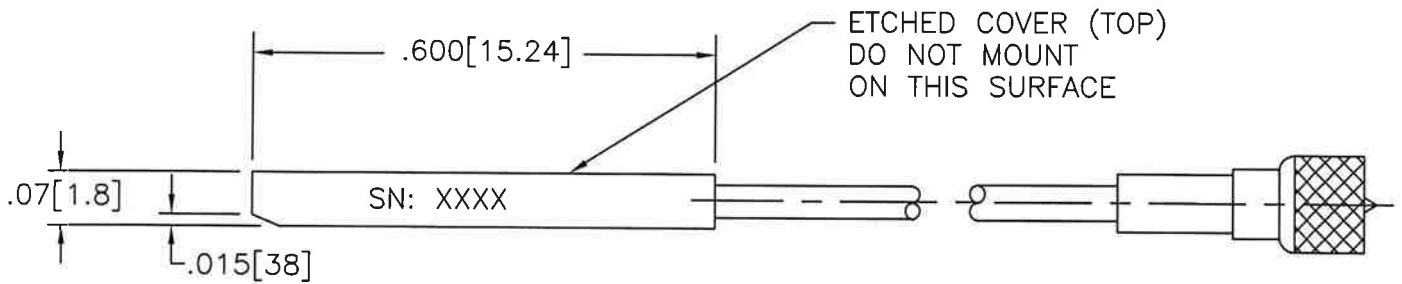
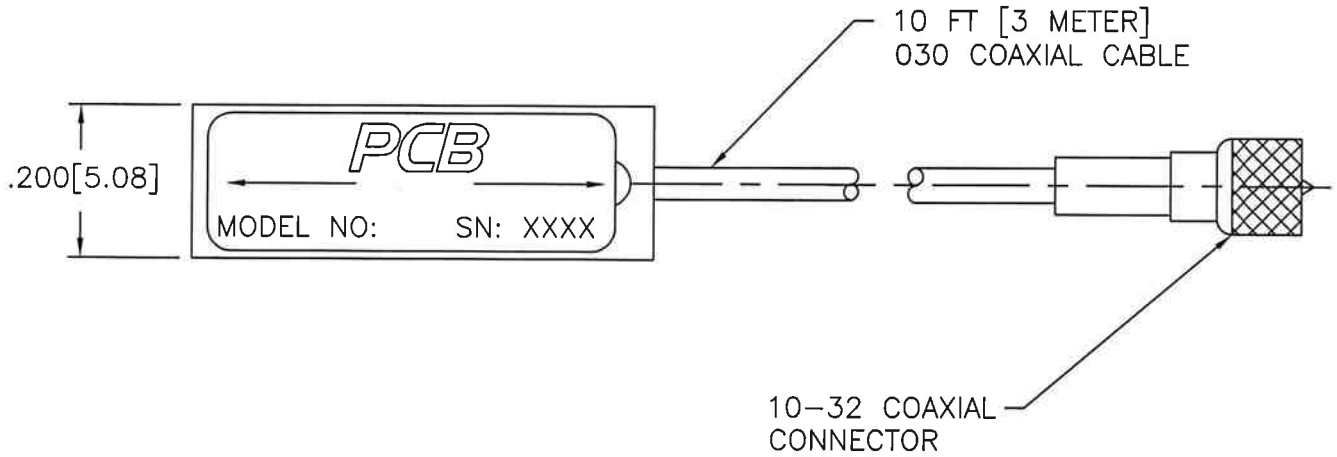

UNLESS SPECIFIED TOLERANCES		DRAWN	MDF	3/3/08	MFG	DC	3/3/08	 3425 WALDEN AVE. DEPEW, NY 14043 (716) 684-0001 EMAIL: SALES@PCB.COM	
DIMENSIONS IN INCHES	DIMENSIONS IN MILLIMETERS [IN BRACKETS]	CHK'D	MDF	3/3/08	ENGR	BM	3/3/08		
DECIMALS XX ±.03 XXX ±.010	DECIMALS X ±0.8 XX ±0.25	APP'D	EB	3/3/08	SALES	RL	3/3/08		
ANGLES ±2 DEGREES	ANGLES ±2 DEGREES	TITLE OUTLINE DRAWING MODEL 740 SERIES LOW PROFILE STRAIN GAUGE							CODE IDENT. NO. 52681
FILLETS AND RADII .003 - .005	FILLETS AND RADII [0.07 - 0.13]							DWG. NO. 9600	
DD011 REV. D 01/17/08								SCALE: 4X	SHEET 1 OF 1