



Model 3713F1210G

Triaxial MEMS DC accelerometer, 135 mV/g, 10 g, single-ended, 10 ft integral cable

Installation and Operating Manual

**For assistance with the operation of this product,
contact the PCB Piezotronics, Inc.**

Toll-free: 716-684-0001

24-hour SensorLine: 716-684-0001

Fax: 716-684-0987

E-mail: info@pcb.com

Web: www.pcb.com



Repair and Maintenance

PCB guarantees Total Customer Satisfaction through its “Lifetime Warranty Plus” on all Platinum Stock Products sold by PCB and through its limited warranties on all other PCB Stock, Standard and Special products. Due to the sophisticated nature of our sensors and associated instrumentation, **field servicing and repair is not recommended and, if attempted, will void the factory warranty.**

Beyond routine calibration and battery replacements where applicable, our products require no user maintenance. Clean electrical connectors, housings, and mounting surfaces with solutions and techniques that will not harm the material of construction. Observe caution when using liquids near devices that are not hermetically sealed. Such devices should only be wiped with a dampened cloth—never saturated or submerged.

In the event that equipment becomes damaged or ceases to operate, our Application Engineers are here to support your troubleshooting efforts 24 hours a day, 7 days a week. Call or email with model and serial number as well as a brief description of the problem.

Calibration

Routine calibration of sensors and associated instrumentation is necessary to maintain measurement accuracy. We recommend calibrating on an annual basis, after exposure to any extreme environmental influence, or prior to any critical test.

PCB Piezotronics is an ISO-9001 certified company whose calibration services are accredited by A2LA to ISO/IEC 17025, with full traceability to SI through N.I.S.T. In addition to our standard calibration services, we also offer specialized tests, including: sensitivity at elevated or cryogenic temperatures, phase response, extended high or low frequency response, extended range, leak testing, hydrostatic pressure testing, and others. For more information, contact your local PCB Piezotronics distributor, sales representative, or factory customer service representative.

Returning Equipment

If factory repair is required, our representatives will provide you with a Return Material Authorization (RMA) number, which we use to reference any information you have already provided and expedite the repair process. This number should be clearly marked on the outside of all returned package(s) and on any packing list(s) accompanying the shipment.

Contact Information

PCB Piezotronics, Inc.
3425 Walden Ave.
Depew, NY14043 USA
Toll-free: (800) 828-8840
24-hour SensorLine: (716) 684-0001
General inquiries: info@pcb.com
Repair inquiries: rma@pcb.com

For a complete list of distributors, global offices and sales representatives, visit our website, www.pcb.com.

Safety Considerations

This product is intended for use by qualified personnel who recognize shock hazards and are familiar with the precautions required to avoid injury. While our equipment is designed with user safety in mind, the protection provided by the equipment may be impaired if equipment is used in a manner not specified by this manual.

Discontinue use and contact our 24-Hour Sensorline if:

- Assistance is needed to safely operate equipment
- Damage is visible or suspected
- Equipment fails or malfunctions

For complete equipment ratings, refer to the enclosed specification sheet for your product.

Definition of Terms and Symbols

The following symbols may be used in this manual:



DANGER

Indicates an immediate hazardous situation, which, if not avoided, may result in death or serious injury.

**CAUTION**

Refers to hazards that could damage the instrument.

**NOTE**

Indicates tips, recommendations and important information. The notes simplify processes and contain additional information on particular operating steps.

The following symbols may be found on the equipment described in this manual:



This symbol on the unit indicates that high voltage may be present. Use standard safety precautions to avoid personal contact with this voltage.



This symbol on the unit indicates that the user should refer to the operating instructions located in the manual.



This symbol indicates safety, earth ground.



PCB工业监视和测量设备 - 中国RoHS2公布表

PCB Industrial Monitoring and Measuring Equipment - China RoHS 2 Disclosure Table

部件名称	有害物质					
	铅 (Pb)	汞 (Hg)	镉 (Cd)	六价铬 (Cr(VI))	多溴联苯 (PBB)	多溴二苯醚 (PBDE)
住房	0	0	0	0	0	0
PCB板	X	0	0	0	0	0
电气连接器	0	0	0	0	0	0
压电晶体	X	0	0	0	0	0
环氧	0	0	0	0	0	0
铁氟龙	0	0	0	0	0	0
电子	0	0	0	0	0	0
厚膜基板	0	0	X	0	0	0
电线	0	0	0	0	0	0
电缆	X	0	0	0	0	0
塑料	0	0	0	0	0	0
焊接	X	0	0	0	0	0
铜合金/黄铜	X	0	0	0	0	0
本表格依据 SJ/T 11364 的规定编制。						
0：表示该有害物质在该部件所有均质材料中的含量均在 GB/T 26572 规定的限量要求以下。						
X：表示该有害物质至少在该部件的某一均质材料中的含量超出 GB/T 26572 规定的限量要求。						
铅是欧洲RoHS指令2011/65/ EU附件三和附件四目前由于允许的豁免。						

CHINA RoHS COMPLIANCE

Component Name	Hazardous Substances					
	Lead (Pb)	Mercury (Hg)	Cadmium (Cd)	Chromium VI Compounds (Cr(VI))	Polybrominated Biphenyls (PBB)	Polybrominated Diphenyl Ethers (PBDE)
Housing	O	O	O	O	O	O
PCB Board	X	O	O	O	O	O
Electrical Connectors	O	O	O	O	O	O
Piezoelectric Crystals	X	O	O	O	O	O
Epoxy	O	O	O	O	O	O
Teflon	O	O	O	O	O	O
Electronics	O	O	O	O	O	O
Thick Film Substrate	O	O	X	O	O	O
Wires	O	O	O	O	O	O
Cables	X	O	O	O	O	O
Plastic	O	O	O	O	O	O
Solder	X	O	O	O	O	O
Copper Alloy/Brass	X	O	O	O	O	O

This table is prepared in accordance with the provisions of SJ/T 11364.

O: Indicates that said hazardous substance contained in all of the homogeneous materials for this part is below the limit requirement of GB/T 26572.

X: Indicates that said hazardous substance contained in at least one of the homogeneous materials for this part is above the limit requirement of GB/T 26572.

Lead is present due to allowed exemption in Annex III or Annex IV of the European RoHS Directive 2011/65/EU.

General OPERATING GUIDE

for use with

High Sensitivity DC ACCELEROMETERS

PCB ASSUMES NO RESPONSIBILITY FOR DAMAGE CAUSED TO THIS PRODUCT AS A RESULT OF PROCEDURES THAT ARE INCONSISTENT WITH THIS OPERATING GUIDE

1.0 Introduction

This operating guide contains information that will familiarize the user with the basic operation and installation of the 3700 Series MEMS DC Accelerometers. However, it is not intended to cover all of the specific measurement challenges that one may encounter while using the device. Therefore, if you have detailed questions or are unsure of how to properly operate the sensor after reading this “Operating Guide”, please contact a PCB Application Engineer using our 24-Hour SensorLine™ at 716-684-0001.

2.0 Common Applications and Features

The 3700 Series MEMS DC Accelerometers achieve true DC response for measuring uniform (or constant) acceleration and low-frequency vibration. For this reason, they are often used to:

- Perform ride quality assessments of elevators, automobiles, trains, and amusement park rides.
- Analyze the low frequency characteristics of buildings, bridges, and large aerospace objects.
- Acquire tilt and orientation data for feedback control and stabilization purposes.

Because of the critical nature of these and similar test applications, all 3700 series MEMS DC Accelerometers have been designed and manufactured with the following common characteristics:

- Built-in electronics provide conveniently standardized sensitivities and low-noise output signals unmatched by similar sensing technologies.
- Internal voltage regulator allows sensor to be powered from virtually any unregulated DC voltage source, such as a bench-top power supply or portable battery source.
- Gas damping extends the upper frequency range, attenuates unwanted high-frequency vibration, and provides stable performance over the entire operating temperature range.

3.0 Principle of Operation

The sensor element of the 3700 series features a proof mass, ring frame, and attachment system between the two. These features are micro machined from the same single-crystal silicon wafer. The movement of the proof mass is directly affected by acceleration applied in the axis of sensitivity.

The sensor element is connected as a bridge element in the circuit. The electrical characteristics of one portion of the bridge increase in value while the characteristics of the other portion decrease when exposed to acceleration. This approach minimizes common mode errors and improves non-linearity.

A selection of full scale measurement ranges is attained by modifying the stiffness of the suspension system of the proof mass. A high natural frequency is accomplished through the combination of a lightweight proof mass and suspension stiffness.

Ruggedness is enhanced through the use of mechanical stops to restrict the travel of the proof mass. Damping is used to mitigate high frequency inputs.

The sensor elements use squeeze-film gas damping. This is the result of the movement of the proof mass pressing on the gas in the gap between it and the outer sensor layer. Damping helps prevent the output of the accelerometer from becoming saturated, as would happen when the resonance of an accelerometer with no damping is excited by random vibration. The advantage of gas damping over liquid damping is that it is minimally affected by temperature changes.

The 3710 series accelerometers contain conditioning circuitry that provides a high sensitivity output. This ASIC (Application Specific Integrated Circuit) also provides compensation of zero bias and sensitivity errors over temperature.

4.0 Typical Measurement System

The 3700 series DC Accelerometers are available in a uniaxial or triaxial package. The output signal is routed to follow-on signal conditioning via receptacle and associated cable assembly or integral cable. Since the High Sensitivity DC Accelerometers contain a built-in voltage regulator, they may be powered from virtually any power source without adversely affecting sensor performance, please refer to sensor specification for voltage range and current requirements. Consult PCB Application Engineering for signal conditioning options if needed. The output from the signal conditioner is typically routed to readout instrumentation such as oscilloscopes or various model data acquisition instruments.

5.0 Sensor Installation

When choosing an installation technique, be certain to carefully examine the different application characteristics that may affect sensor performance. Characteristics such as mounting location may limit the use of large mounting blocks or the amplitude range may necessitate the use of a stud mount rather than using adhesive. A summary of the recommended mounting methods is provided below.

Stud Mount: Recommended for permanent mount applications or in test situations that require a rugged or secure installation. The necessary information, including surface finish, mounting hole dimensions, and recommended mounting torque for installing the sensor is listed on the enclosed Sensor Installation Drawing. It is recommended that an experienced technician or machinist with good machining capabilities adequately prepare the surface.

Adhesive Mount: Recommended for temporary mounting of the sensor or when the test object surface cannot be properly prepared for stud mounting. Wax works well for temporary mount applications under conditions where the operating temperature will not melt the wax or the acceleration levels will not dislodge the sensor from the test object. If using cyanoacrylate-based adhesives for a quick mounting method or two-part epoxies for a more secure mount, PCB recommends mounting DC accelerometers via an adhesive mounting base. The base acts as a sacrificial part allowing safe removal of accelerometer after test is completed. If a base is not used, care must be taken as to not damage the sensor during removal.

NOTE: *A chemical debonder should always be used*

With so many adhesives in use (everything from super glues, dental cement, epoxies, etc), there is no universal de-bonding agent available. The de-bonder for the Loctite 454 adhesive that PCB offers is Acetone. If you are using anything other than Loctite 454, you will have to check with the individual manu-

facturers for their de-bonding recommendations. The de-bonding agent must be allowed to penetrate the surface in order to properly react with the adhesive, so it is advisable to wait a few minutes before removing the sensor.

After the de-bonding agent has softened the adhesive, use a gentle shearing (or twisting) motion to remove the base and/or sensor from the test structure.

Easy Mount Clip: Recommended when frequent installation and removal of Series 3700 series accelerometers is desired. Depending on the Easy-Mount Clip design, it can either be stud mounted or adhesively mounted to the test structure. (If adhesively mounting the clip, detach the sensor from the clip first, as excessive adhesive may creep through the mounting holes and adhere to the sensor. This will make separation and removal from the clip difficult.) Once the Easy-Mount Clip has been attached to the test structure, the sensor can be easily snapped into and out of the clip. Over time, the Easy-Mount Clip must be replaced as it will “wear-out” and eventually lose its ability to securely hold the sensor.

6.0 Powering

The 3710 Series contains built-in microelectronics that will operate from many PCB Sensor Signal Conditioners. These signal conditioners provide the necessary voltage and current required for all of the powering options available on the 3700 series. If a signal conditioner is needed, please consult with the factory for the proper conditioner that best fits the application.

The 3700 series may also be powered by other voltage sources such as DC voltage laboratory supplies, automotive or marine batteries, or low-voltage supplies designed for powering PC Board components. Ensure that the source provides power within the excitation voltage range and current listed on the specification sheet for that model. It is important to note that since the accelerometers contain a built-in voltage regulator, precise calibration of the power source is generally not required.

7.0 Operation

After the sensor has been installed and the cable connected for proper operation, there are a couple of measurement points to take note of:

- To take advantage of the DC response of the accelerometer, the readout device must be in a DC coupled state. Consult the appropriate manufacturer or product manual for your readout device for details.
- Because the 3700 series can measure static (constant) accelerations, the DC offset voltage will be affected by the positional alignment relative to the Earth's gravity. In other

Manual Number: 32650
Manual Revision: E
ECR Number: 53457

words, when the sensor is mounted perpendicular with the Earth's surface, the offset will equal that as specified on the calibration certificate for "zero-g offset voltage." If the sensor is mounted parallel with the Earth's surface, the sensor will be experiencing 1 g of acceleration and the offset voltage will increase by the sensitivity of the accelerometer.

- If the sensor is extended, in the case of an integral cable sensor, or a cable length other than 10 ft is used, in the case of sensor with an integral connector, the offset voltage will change. To determine the accelerometer's offset, rotate the unit 90° so that the sensor is on its side with the sensing axis perpendicular to Earth's gravity and record the DC output. This value is the new "zero-g offset voltage."
- To ensure that ground loops are not induced, the shield should only be terminated at one end. Typically, the shield of the cable is tied to the sensor housing. If the sensor is mounted with an isolation pad (or other form of electrical isolation) from the test structure, then the shield should be tied to signal ground at the instrumentation end. Otherwise, leave the cable shield floating or not connected at the instrumentation end.

8.0 Sensor Verification

If the sensor has been handled in a rough manner or before using a sensor for a critical measurement application, it is a good idea to verify that the sensor's sensitivity is still within specification. An accurate static calibration of the 3700 series can be performed using the Earth's Gravitational Field as a reference. The sensor can simply be "flipped" (rotated 180°) in the Earth's Gravity to obtain the scaling factor (sensitivity) and DC offset. First, place the accelerometer in a +1g orientation so that the base is resting on the table and the model number is facing up. The sensing axis will be parallel with the Earth's gravity with the sensor experiencing +1g acceleration. Record the DC output by using a DVM. Then rotate the sensor 180° so that the sensor is inverted (the top of the sensor is resting on the table) and the sensor is experiencing -1g acceleration. Record the DC output. To calculate the sensitivity of the accelerometer, refer to equation 8.1.

$$\text{Sensitivity} = \frac{(+1g) - (-1g)}{2} \quad \text{Eq 8.1}$$

9.0 Sensor Calibration

Due to ISO 9001, ISO Guide 25, or other contractual requirements, it may become necessary to send the accelerometer back to PCB for recalibration. In this case, a complete back-to-back frequency response test will be performed and the "zero-g" offset voltage will be checked with NIST traceable equipment.

10.0 Maintenance and Repair

Because of the sophisticated nature of PCB instrumentation, field repair of the equipment is not recommended. Most PCB sensors are of modular construction and are factory repairable. A repair or replacement quotation is available at no charge. Before returning equipment for repair, it is recommended that the user confer with a factory application engineer (or international representative) to first troubleshoot the problem.

11.0 Return Procedure

To expedite the repair process, contact a factory Application Engineer to obtain a Return Material Authorization (RMA) number prior to sending equipment to the factory. Please have information, such as model number, serial number and description of the problem, available.

Customers outside the U.S. should consult their local PCB distributor for information on returning equipment. For exceptions to this guideline, please contact the International Sales department to request shipping instructions and an RMA.

For further assistance, please call (716) 684-0001 or fax us at (716) 684-0987. You may also receive assistance via e-mail at info@pcb.com or visit our web site at www.pcb.com.

12.0 Customer Service / Warranty

The employees of PCB strive to provide superior, unmatched customer service. Should you at any time find yourself dissatisfied with any PCB product for any reason, consult a factory Application Engineer or local representative/distributor to discuss repair, refund, or exchange procedures.

When unexpected measurement problems arise, call our 24-hour SensorLine™ at (716) 684-0001 to discuss your immediate dynamic instrumentation needs with a PCB Application Engineer.

Model Number
3713F1210G

TRIAxIAL DC RESPONSE ACCELEROMETER

Revision: A
ECN #: 53791

Performance	ENGLISH	SI	
Sensitivity(± 3 %)	135 mV/g	13.8 mV/(m/s ²)	[1]
Measurement Range	± 10 g pk	± 98.1 m/s ² pk	
Frequency Range(± 5 %)	0 to 1,000 Hz	0 to 1,000 Hz	
Frequency Range(± 10 %)	0 to 1,500 Hz	0 to 1,500 Hz	
Resonant Frequency	3.2 kHz	3.2 kHz	[2]
Phase Response(100 Hz)	< 10 °	< 10 °	
Non-Linearity(Typical)	0.3 %	0.3 %	[3]
Non-Linearity(Max)	1 %	1 %	[3]
Broadband Resolution(0.5 to 100 Hz)	0.3 mg rms	0.003 m/s ² rms	[2]
Transverse Sensitivity(Typical)	1 %	1 %	
Transverse Sensitivity(Max)	3 %	3 %	
Environmental			
Overload Limit(Shock)	± 5,000 g pk	± 49,050 m/s ² pk	
Temperature Range(Operating)	-65 to +250 °F	-54.0 to +121 °C	
Temperature Range(Storage)	-65 to +250 °F	-54.0 to +121 °C	
Temperature Coefficient of Sensitivity	± 1 %	± 1 %	[4][2]
Zero g Offset Temperature Coefficient	± 1 % FSO	± 1 % FSO	[4][5][2]
Base Strain Sensitivity	.001 g/με	.01 (m/s ²)/με	[2]
Magnetic Sensitivity	40 μg/gauss	3.9 (m/s ²)/Tesla	[2]
Electrical			
Excitation Voltage	5 to 28 VDC	5 to 28 VDC	
Current Consumption	≤ 15 mA	≤ 15 mA	
Output Impedance	≤ 120 Ohm	≤ 120 Ohm	
Offset Voltage(0 g)	± 20 mVDC	± 20 mVDC	[6]
Spectral Noise(1 Hz)	30 μg/√Hz	294 (μm/s ²)/√Hz	[2]
Spectral Noise(10 Hz)	30 μg/√Hz	294 (μm/s ²)/√Hz	[2]
Spectral Noise(100 Hz)	30 μg/√Hz	294 (μm/s ²)/√Hz	[2]
Electrical Isolation(Case)	> 10 ⁸ Ohm	> 10 ⁸ Ohm	
Physical			
Housing Material	Titanium	Titanium	
Sealing	Hermetic	Hermetic	
Size (Length x Width x Height)	0.8 in x 0.8 in x 0.8 in	20.3 mm x 20.3 mm x 20.3 mm	
Weight(with cable)	4.2 oz	119 gm	
Electrical Connector	Integral Cable	Integral Cable	
Electrical Connection Position	Side	Side	
Cable Type	037 10-cond Shielded	037 10-cond Shielded	
Cable Length	10 ft	3.05 m	
Mounting Thread	10-32 Female	10-32 Female	

OPTIONAL VERSIONS

Optional versions have identical specifications and accessories as listed for the standard model except where noted below. More than one option may be used.

NOTES:

- [1] Measured at 100 Hz, 1 grms.
- [2] Typical.
- [3] Zero-based, least-squares, straight line method.
- [4] -65 to +250 °F, ref. 75 °F (-54 to +121 °C, ref. 24 °C)
- [5] FSO= Full Scale Output over the Measurement Range
- [6] Offset tolerance is based on 10 ft of 037 test cable.
- [7] See PCB Declaration of Conformance PS027 for details.

SUPPLIED ACCESSORIES:

- Model 080A12 Adhesive Mounting Base (1)
- Model 081B05 Mounting Stud (10-32 to 10-32) (1)
- Model ACS-172T Triaxial Phase and Amplitude Calibration from 5 Hz to +5% frequency range (1)
- Model M081B05 Mounting Stud 10-32 to M6 X 0.75 (1)



Entered: ND	Engineer: NJF	Sales: JM	Approved: BAM	Spec Number:
Date: 05/16/2023	Date: 05/16/2023	Date: 05/16/2023	Date: 05/16/2023	70752

PCB PIEZOTRONICS Phone: 716-684-0001
 AN AMPHENOL COMPANY Fax: 716-684-0987
 E-Mail: info@pcb.com

3425 Walden Avenue, Depew, NY 14043

All specifications are at room temperature unless otherwise specified.
 In the interest of constant product improvement, we reserve the right to change specifications without notice.

081-XXXX-90

PCB Piezotronics Inc. claims proprietary rights in the information disclosed hereon. Neither it nor any reproduction thereof will be disclosed to others without the written consent of PCB Piezotronics Inc.

STANDARD STUD MOUNT

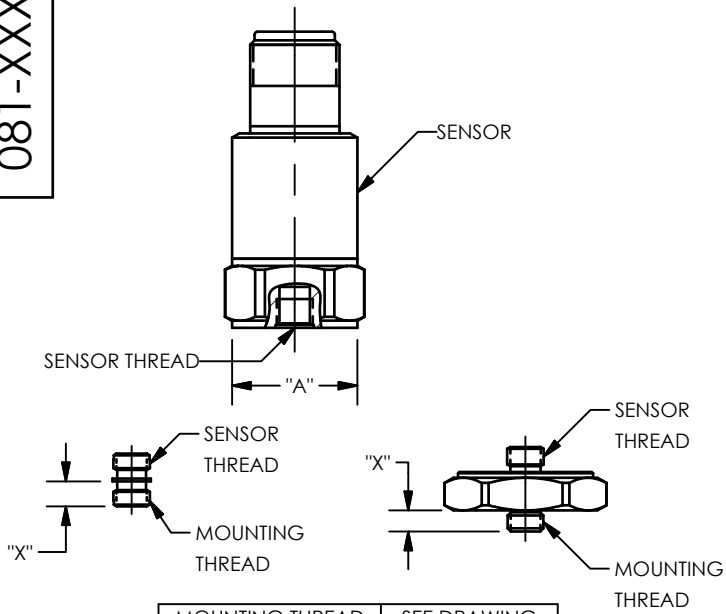

MOUNTING THREAD	SEE DRAWING
5-40	A
M3 X 0.50	B
10-32	C
M5 X 0.80	D
1/4-28	E
M6 X 1.00	F

"A"
5-40
MOUNTING INSTRUCTIONS
(METRIC DIMENSIONS IN BRACKETS)

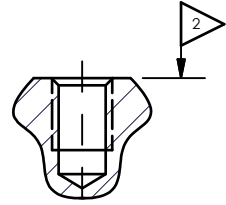

MOUNTING HOLE PREPARATION:
 1) $\phi .101 [\phi 2.57]$
 X $.20 [5.1] \nabla$ MIN.
 5-40 UNC-2B
 X $.15 [3.8] \nabla$ MIN.

4.) RECOMMENDED MOUNTING TORQUE,
 4-5 INCH POUNDS
 [45-55 NEWTON CENTIMETERS].

"B"
M3 X 0.50
MOUNTING INSTRUCTIONS
(ENGLISH DIMENSIONS IN BRACKETS)

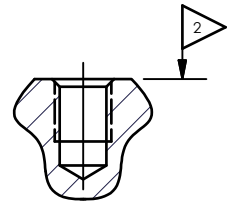

MOUNTING HOLE PREPARATION:
 1) $\phi 2.5 [\phi .099]$
 X $4.6 [1.8] \nabla$ MIN.
 M3 X 0.50-6H
 X $3.3 [1.3] \nabla$ MIN.

4.) RECOMMENDED MOUNTING TORQUE,
 45-55 NEWTON CENTIMETERS
 [4-5 INCH POUNDS].

"C"
10-32
MOUNTING INSTRUCTIONS
(METRIC DIMENSIONS IN BRACKETS)

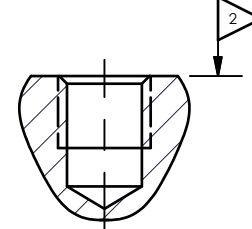

MOUNTING HOLE PREPARATION:
 1) $\phi .159 [\phi 4.04]$
 X $.23 [5.8] \nabla$ MIN.
 10-32 UNF-2B
 X $.15 [3.8] \nabla$ MIN.

4.) RECOMMENDED MOUNTING TORQUE,
 10-20 INCH POUNDS
 [113-225 NEWTON CENTIMETERS].

"D"
M5 X 0.80
MOUNTING INSTRUCTIONS
(ENGLISH DIMENSIONS IN BRACKETS)

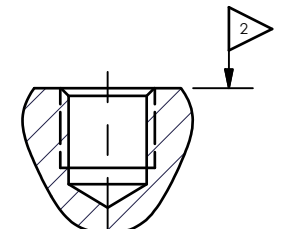

MOUNTING HOLE PREPARATION:
 1) $\phi 4.22 [\phi .166]$
 X $7.62 [300] \nabla$ MIN.
 M5 X 0.8-6H
 X $5.08 [200] \nabla$ MIN.

4.) RECOMMENDED MOUNTING TORQUE,
 113-225 NEWTON CENTIMETERS
 [10-20 INCH POUNDS].

REVISIONS		
REV	DESCRIPTION	DIN
R	CHANGED "B" HOLE TOLERANCE	53828

INTEGRAL STUD MOUNT

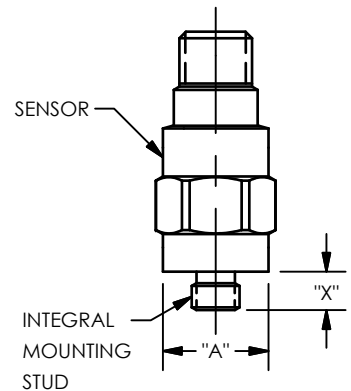

MOUNTING THREAD	SEE DRAWING
5-40	A
M3 X 0.50	B
10-32	C
M5 X 0.80	D
1/4-28	E
M6 X 1.00	F

"THRU-BOLT" STUD MOUNT

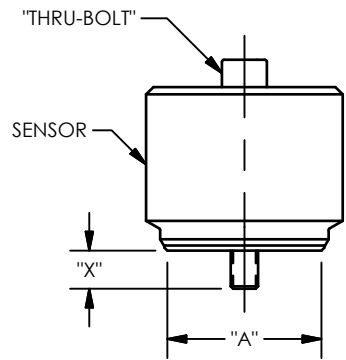

BOLT THREAD	SEE DRAWING
10-32	C
M5 X 0.80	D
1/4-28	E
M6 X 1.00	F
M8 X 1.25	F

"E"
1/4-28
MOUNTING INSTRUCTIONS
(METRIC DIMENSIONS IN BRACKETS)

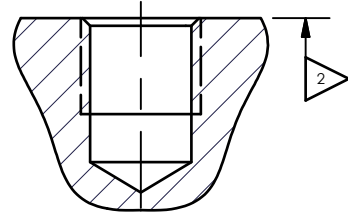

MOUNTING HOLE PREPARATION:
 1) $\phi .218 [\phi 5.54]$
 X $.300 [7.62] \nabla$ MIN.
 1/4-28 UNF-2B
 X $.200 [5.08] \nabla$ MIN.

4.) RECOMMENDED MOUNTING TORQUE,
 2-5 FOOT POUNDS
 [3-7 NEWTON METERS].

"F"
M6 X 0.75, M6 X 1.00, M8 X 1.25
MOUNTING INSTRUCTIONS
(ENGLISH DIMENSIONS IN BRACKETS)

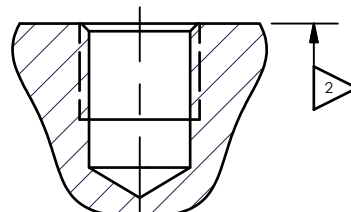

M6 X 0.75 MOUNTING HOLE PREPARATION:
 1) $\phi 5.31 [\phi .209]$
 X $7.62 [300] \nabla$ MIN.
 M6 X 0.75-6H
 X $5.08 [200] \nabla$ MIN.

M6 X 1.0 MOUNTING HOLE PREPARATION:
 1) $\phi 5.05 [\phi .199]$
 X $8.10 [320] \nabla$ MIN.
 M6 X 1.0-6H
 X $6.35 [250] \nabla$ MIN.

4.) RECOMMENDED MOUNTING TORQUE,
 3-7 NEWTON METERS [2-5 FT POUNDS].

M8 X 1.25 MOUNTING HOLE PREPARATION:
 1) $\phi 6.75 [\phi .266]$
 X $8.64 [340] \nabla$ MIN.
 M8 X 1.25-6H
 X $5.00 [197] \nabla$ MIN.

"G"
MOUNTING INSTRUCTIONS
FOR SPECIAL THREAD LENGTHS
(METRIC DIMENSIONS IN BRACKETS)

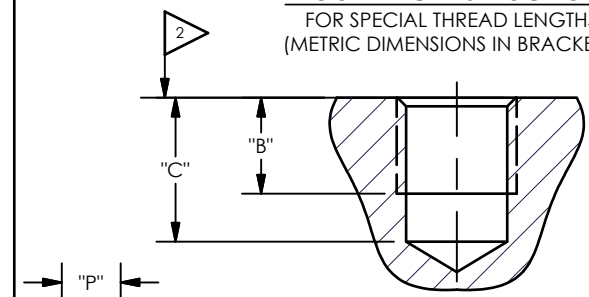

MOUNTING HOLE PREPARATION:
 1) ϕ DRILL DIA.
 X "C" ∇ MIN.
 TAP
 X "B" ∇ MIN.

THREAD DEPTH : B = X + 1 THREAD PITCH
 DRILL DEPTH : C = B + 3 THREAD PITCH
 SEE A-F FOR APPROPRIATE DRILL AND TAP
 THREAD PITCH = 1/TPI [P]

- 3.) FOR BEST RESULTS, PLACE A THIN LAYER OF SILICONE GREASE (OR EQUIVALENT) ON INTERFACE PRIOR TO MOUNTING.
- 2) MOUNTING SURFACE SHOULD BE FLAT TO WITHIN .001 (0.03) TIR OVER DIM 'A' WITH A $63 [1.61] \nabla$ OR BETTER FINISH FOR BEST RESULTS.
- 1) DRILL PERPENDICULAR TO MOUNTING SURFACE TO WITHIN $\pm 1^\circ$.

UNLESS OTHERWISE SPECIFIED TOLERANCES ARE:

DIMENSIONS IN INCHES		DIMENSIONS IN MILLIMETERS [IN BRACKETS]	
DECIMALS	XX $\pm .01$ XXX $\pm .005$	DECIMALS	X ± 0.3 XX ± 0.13
ANGLES ± 2 DEGREES		ANGLES ± 2 DEGREES	
CABLE TOLERANCES IN ENGLISH		CABLE TOLERANCES IN METRIC	
1" \leq LENGTH < 1'	= $+1' / -0$	2.54cm \leq LENGTH < 30.5cm	= $+2.54cm / -0$
1' \leq LENGTH < 5'	= $+2' / -0$	30.5cm \leq LENGTH < 1.5m	= $+5.1cm / -0$
5' \leq LENGTH < 100'	= $+6' / -0$	1.5m \leq LENGTH < 30.5m	= $+15.2cm / -0$
100' \leq LENGTH	= $+1' / -0$	30.5m \leq LENGTH	= $+30.5cm / -0$
FILLETS AND RADII .003 - .005		FILLETS AND RADII 0.07 - 0.13	

DRAWN		CHECKED		ENGINEER	
NJF	05/03/23	JDM	05/03/23	MJN	05/03/23

TITLE
 INSTALLATION DRAWING
 FOR STANDARD
 081 SERIES MOUNTING

PCB PIEZOTRONICS
 AN AMPHENOL COMPANY
 3425 WALDEN AVE. DEPEW, NY 14043
 (716) 684-0001 E-MAIL: sales@pcb.com

CODE IDENT. NO. 52681	DWG. NO. 081-XXXX-90
SCALE: NONE	SHEET 1 OF 1

PCB Piezotronics Inc. claims proprietary rights in the information disclosed hereon. Neither it nor any reproduction thereof will be disclosed to others without the written consent of PCB Piezotronics Inc.

70758

REVISIONS		
REV	DESCRIPTION	DIN
NR	RELEASED TO DRAFTING	49386

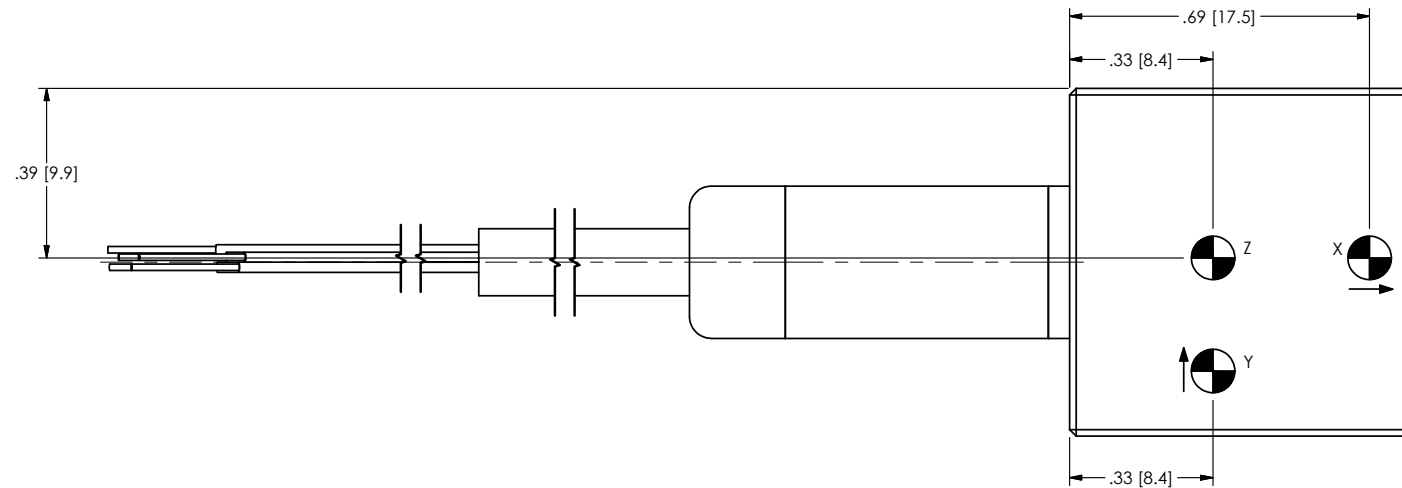

CABLE PIGTAILS:

- 1.) RED (POWER)
- 2.) ORANGE (X OUTPUT)
- 3.) GREEN (Y OUTPUT)
- 4.) WHITE (Z OUTPUT)
- 5.) BLACK (POWER/SIGNAL GROUND)
- 6.) NOT USED, (BLUE) TRIMMED FLUSH
- 7.) NOT USED, (YELLOW) TRIMMED FLUSH
- 8.) NOT USED, (GRAY) TRIMMED FLUSH
- 9.) NOT USED, (BROWN) TRIMMED FLUSH
- 10.) NOT USED, (PURPLE) TRIMMED FLUSH

OUTPUT SIGNAL:
REFERENCE TO GROUND

POWER:
CONNECT TO DC VOLTAGE
POWER SUPPLY . SEE
SPECIFICATION SHEET FOR
PROPER EXCITATION VOLTAGE

SHIELD:
CASE GROUND

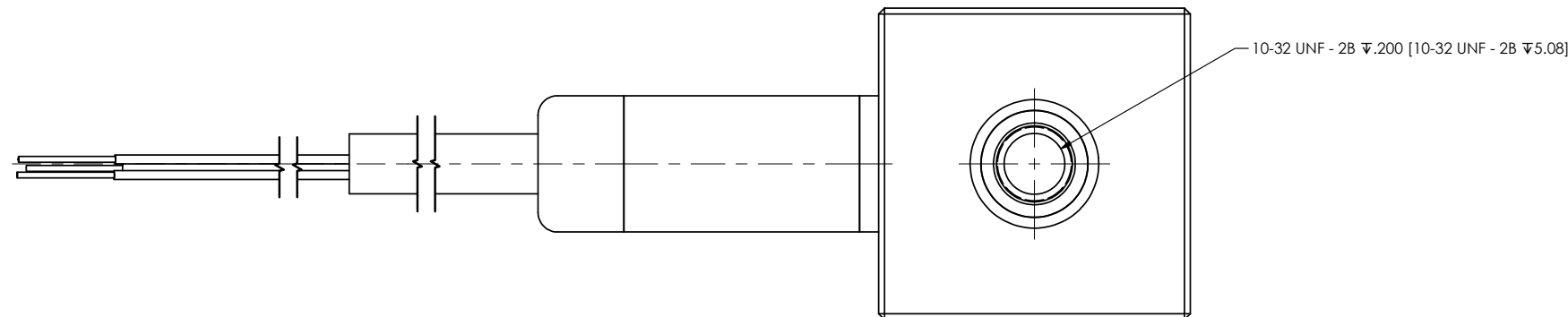
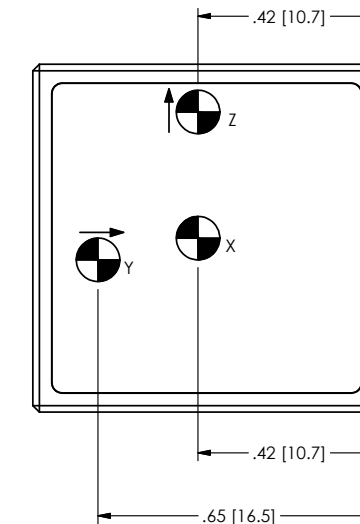
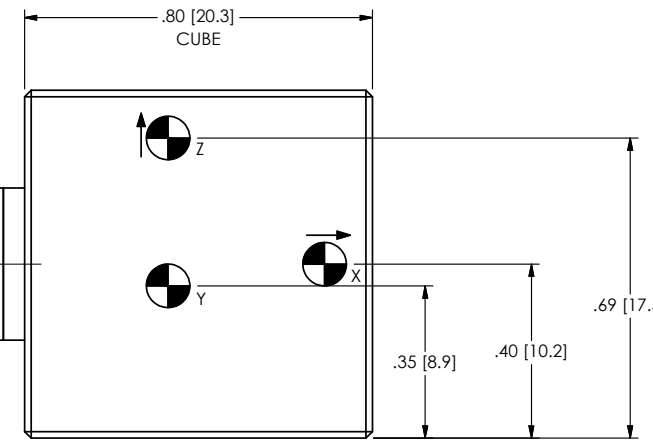
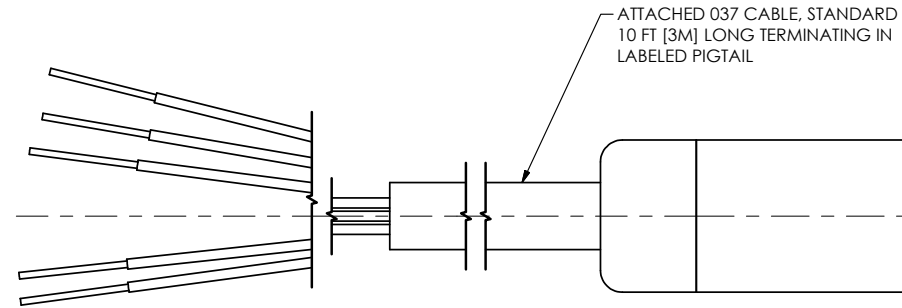

4.) SEE SHEET 2 OF 2 FOR CABLE STRAIN RELIEF INFORMATION

3.) DENOTES CG-CENTER OF SEISMIC MEASUREMENT

2.) MOUNTING SURFACE SHOULD BE FLAT TO WITHIN .001 [.03] TIR OVER $\varnothing 1.20 [30.5]$ WITH A MINIMUM FINISH OF 32 [.08] FOR BEST RESULTS

1.) DRILL PERPENDICULAR TO MOUNTING SURFACE TO WITHIN $\pm 1^\circ$

UNLESS OTHERWISE SPECIFIED TOLERANCES ARE:		DRAWN	CHECKED	ENGINEER	
DIMENSIONS IN INCHES	DIMENSIONS IN MILLIMETERS [IN BRACKETS]	JES	4/19/19	JDM	4/19/19
DECIMALS XX $\pm .03$ XXX $\pm .010$	DECIMALS X ± 0.8 XX ± 0.25	TITLE		NF	4/19/19
ANGLES ± 2 DEGREES	ANGLES ± 2 DEGREES	OUTLINE DRAWING MODEL 3713F12XXXG TRIAxIAL ACCELEROMETER			
FILLETS AND RADII .003 - .005	FILLETS AND RADII 0.07 - 0.13	CODE IDENT. NO. 52681		DWG. NO. 70758	
		SCALE: 3.5X		SHEET 1 OF 2	

PCB PIEZOTRONICS
3425 WALDEN AVE. DEPEW, NY 14043
(716) 684-0001 E-MAIL: sales@pcb.com

PCB Piezotronics Inc. claims proprietary rights in the information disclosed hereon. Neither it nor any reproduction thereof will be disclosed to others without the written consent of PCB Piezotronics Inc.

70758

REVISIONS

REV	DESCRIPTION	DIN
	-SEE SHEET 1	

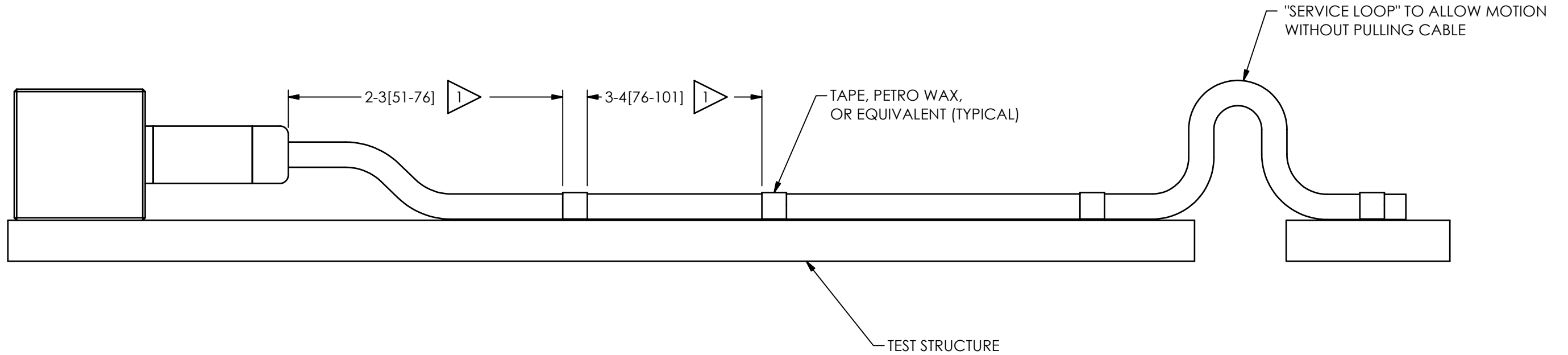

1 FASTEN CABLE TO TEST STRUCTURE TYPICALLY WITHIN 2-3"[51-76] OF SENSOR, THEN FASTEN AGAIN WITHIN 3-4"[76-101] OF PREVIOUS ATTACHMENT. BETWEEN THE TEST STRUCTURE AND A FIXED STRUCTURE, ALLOW A SERVICE LOOP LARGE ENOUGH TO PREVENT PULLING OF THE CABLE WHEN SHAKING. MORE ATTACHMENT POINTS WILL PROVIDE LESS NOISE IN THE RESULTING DATA. LOOSE CABLES OR PARTS ELSEWHERE ON THE TEST STRUCTURE CAN ALSO GENERATE "NOISE" ON THE SIGNAL RECEIVED FROM THE MODEL 3713 SERIES.

UNLESS OTHERWISE SPECIFIED TOLERANCES ARE:		DRAWN		CHECKED		ENGINEER	
DIMENSIONS IN INCHES	DIMENSIONS IN MILLIMETERS [IN BRACKETS]	JES	4/19/19	JDM	4/19/19	NF	4/19/19
DECIMALS XX ±.03 XXX ±.010	DECIMALS X ±.08 XX ±.025	TITLE OUTLINE DRAWING MODEL 3713F12XXXG TRIAxIAL ACCELEROMETER					
ANGLES ± 2 DEGREES	ANGLES ± 2 DEGREES						
FILLETS AND RADII .003 - .005	FILLETS AND RADII 0.07 - 0.13	CODE IDENT. NO. 52681		DWG. NO. 70758		SCALE: 1.5X SHEET 2 OF 2	



3425 WALDEN AVE. DEPEW, NY 14043
(716) 684-0001 E-MAIL: sales@pcb.com