



Model 1631-03C

PCB L&T S-Type Load Cell, 1,000 lbf rated capacity, 65% static overload protection, 2mV/V output, 1/2-20 UNF threads, integrated 10 foot cable w/ open end, aluminum construction

Installation and Operating Manual

**For assistance with the operation of this product,
contact the PCB Piezotronics, Inc.**

**Toll-free: 716-684-0001
24-hour SensorLine: 716-684-0001
Fax: 716-684-0987
E-mail: info@pcb.com
Web: www.pcb.com**



Repair and Maintenance

PCB guarantees Total Customer Satisfaction through its “Lifetime Warranty Plus” on all Platinum Stock Products sold by PCB and through its limited warranties on all other PCB Stock, Standard and Special products. Due to the sophisticated nature of our sensors and associated instrumentation, **field servicing and repair is not recommended and, if attempted, will void the factory warranty.**

Beyond routine calibration and battery replacements where applicable, our products require no user maintenance. Clean electrical connectors, housings, and mounting surfaces with solutions and techniques that will not harm the material of construction. Observe caution when using liquids near devices that are not hermetically sealed. Such devices should only be wiped with a dampened cloth—never saturated or submerged.

In the event that equipment becomes damaged or ceases to operate, our Application Engineers are here to support your troubleshooting efforts 24 hours a day, 7 days a week. Call or email with model and serial number as well as a brief description of the problem.

Calibration

Routine calibration of sensors and associated instrumentation is necessary to maintain measurement accuracy. We recommend calibrating on an annual basis, after exposure to any extreme environmental influence, or prior to any critical test.

PCB Piezotronics is an ISO-9001 certified company whose calibration services are accredited by A2LA to ISO/IEC 17025, with full traceability to SI through N.I.S.T. In addition to our standard calibration services, we also offer specialized tests, including: sensitivity at elevated or cryogenic temperatures, phase response, extended high or low frequency response, extended range, leak testing, hydrostatic pressure testing, and others. For more information, contact your local PCB Piezotronics distributor, sales representative, or factory customer service representative.

Returning Equipment

If factory repair is required, our representatives will provide you with a Return Material Authorization (RMA) number, which we use to reference any information you have already provided and expedite the repair process. This number should be clearly marked on the outside of all returned package(s) and on any packing list(s) accompanying the shipment.

Contact Information

PCB Piezotronics, Inc.
3425 Walden Ave.
Depew, NY14043 USA
Toll-free: (800) 828-8840
24-hour SensorLine: (716) 684-0001
General inquiries: info@pcb.com
Repair inquiries: rma@pcb.com

For a complete list of distributors, global offices and sales representatives, visit our website, www.pcb.com.

Safety Considerations

This product is intended for use by qualified personnel who recognize shock hazards and are familiar with the precautions required to avoid injury. While our equipment is designed with user safety in mind, the protection provided by the equipment may be impaired if equipment is used in a manner not specified by this manual.

Discontinue use and contact our 24-Hour Sensorline if:

- Assistance is needed to safely operate equipment
- Damage is visible or suspected
- Equipment fails or malfunctions

For complete equipment ratings, refer to the enclosed specification sheet for your product.

Definition of Terms and Symbols

The following symbols may be used in this manual:



DANGER

Indicates an immediate hazardous situation, which, if not avoided, may result in death or serious injury.

**CAUTION**

Refers to hazards that could damage the instrument.

**NOTE**

Indicates tips, recommendations and important information. The notes simplify processes and contain additional information on particular operating steps.

The following symbols may be found on the equipment described in this manual:



This symbol on the unit indicates that high voltage may be present. Use standard safety precautions to avoid personal contact with this voltage.



This symbol on the unit indicates that the user should refer to the operating instructions located in the manual.



This symbol indicates safety, earth ground.



PCB工业监视和测量设备 - 中国RoHS2公布表

PCB Industrial Monitoring and Measuring Equipment - China RoHS 2 Disclosure Table

部件名称	有害物质					
	铅 (Pb)	汞 (Hg)	镉 (Cd)	六价铬 (Cr(VI))	多溴联苯 (PBB)	多溴二苯醚 (PBDE)
住房	0	0	0	0	0	0
PCB板	X	0	0	0	0	0
电气连接器	0	0	0	0	0	0
压电晶体	X	0	0	0	0	0
环氧	0	0	0	0	0	0
铁氟龙	0	0	0	0	0	0
电子	0	0	0	0	0	0
厚膜基板	0	0	X	0	0	0
电线	0	0	0	0	0	0
电缆	X	0	0	0	0	0
塑料	0	0	0	0	0	0
焊接	X	0	0	0	0	0
铜合金/黄铜	X	0	0	0	0	0
本表格依据 SJ/T 11364 的规定编制。						
0：表示该有害物质在该部件所有均质材料中的含量均在 GB/T 26572 规定的限量要求以下。						
X：表示该有害物质至少在该部件的某一均质材料中的含量超出 GB/T 26572 规定的限量要求。						
铅是欧洲RoHS指令2011/65/ EU附件三和附件四目前由于允许的豁免。						

CHINA RoHS COMPLIANCE

Component Name	Hazardous Substances					
	Lead (Pb)	Mercury (Hg)	Cadmium (Cd)	Chromium VI Compounds (Cr(VI))	Polybrominated Biphenyls (PBB)	Polybrominated Diphenyl Ethers (PBDE)
Housing	O	O	O	O	O	O
PCB Board	X	O	O	O	O	O
Electrical Connectors	O	O	O	O	O	O
Piezoelectric Crystals	X	O	O	O	O	O
Epoxy	O	O	O	O	O	O
Teflon	O	O	O	O	O	O
Electronics	O	O	O	O	O	O
Thick Film Substrate	O	O	X	O	O	O
Wires	O	O	O	O	O	O
Cables	X	O	O	O	O	O
Plastic	O	O	O	O	O	O
Solder	X	O	O	O	O	O
Copper Alloy/Brass	X	O	O	O	O	O

This table is prepared in accordance with the provisions of SJ/T 11364.

O: Indicates that said hazardous substance contained in all of the homogeneous materials for this part is below the limit requirement of GB/T 26572.

X: Indicates that said hazardous substance contained in at least one of the homogeneous materials for this part is above the limit requirement of GB/T 26572.

Lead is present due to allowed exemption in Annex III or Annex IV of the European RoHS Directive 2011/65/EU.

TABLE OF CONTENTS

1.0 INTRODUCTION	2
2.0 SAFETY PRECAUTIONS	2
3.0 OVERVIEW	2
3.1 Dimensions	2
4.0 MECHANICAL INSTALLATION	2
5.0 ELECTRICAL INSTALLATION	2
5.1 Electrical Drawing / Western Regional Std.	3
5.2 Output Polarity	3
5.3 Cable & Grounding Considerations	3
6.0 CALIBRATION	3
6.1 Calibration Certificate Description.....	3
6.1.1 Measured Output.....	3
6.1.2 Hysteresis.....	4
6.1.3 Best Fit Output.....	4
6.1.4 Strain Gage Measurements	4
6.1.5 Shunt Calibration Standard Resistor	4
6.1.6 Static Error Band (SEB).....	4
7.0 SHUNT CALIBRATION DESCRIPTION	4
7.1 Resistor Value.....	4
7.2 Shunt Calibration Process.....	4
7.3 Estimating Shunt Resistor for a Given Load	4
8.0 MAINTENANCE	4
9.0 TROUBLE SHOOTING	5
9.1 Mechanical Trouble Shooting	5
9.2 Electrical Trouble Shooting	5
10.0 CALIBRATION / REPAIR SERVICES	5
10.1 RMA / Purchase Order.....	5
11.0 WARRANTY	5

1.0 INTRODUCTION

S-type load cells manufactured by PCB Load & Torque, Inc. are accurate strain gage sensors used for weighing and force measurement. Their high accuracy makes them ideally suited for critical weighing applications. S-type load cells are typically used to measure tensile loads, however, compression loads can also be measured when compression loads are guided and any resultant extraneous loads are minimized. Standard 1/4"-28 female threads facilitate ease of installation.

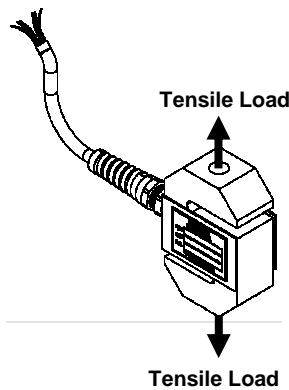

Figure 1 – S-Type Load Cell Loading

The following document explains the characteristics and installation of the S-type load cells.

2.0 SAFETY PRECAUTIONS

Failure of the load cell structure may cause personal injury and equipment damage.

The load cell can withstand loads of at least 150% of the full-scale capacity before any damage occurs to the sensing element. Be sure that the load cell and any fixturing used is properly designed, fabricated, and securely installed prior to use.

3.0 OVERVIEW

S-type load cells come in a variety of capacities to handle loads ranging from 50 lbf to 5k lbf.

Table 1 - Full-Scale Capacities

Full-Scale Capacities		
Model	(lbf)	(N)
1630-03C	50	222
1630-04C	100	445
1630-06C	250	1112
1631-01C	500	2224
1631-03C	1000	4448
1631-04C	2000	8896
1631-06C	5000	22241

3.1 Dimensions

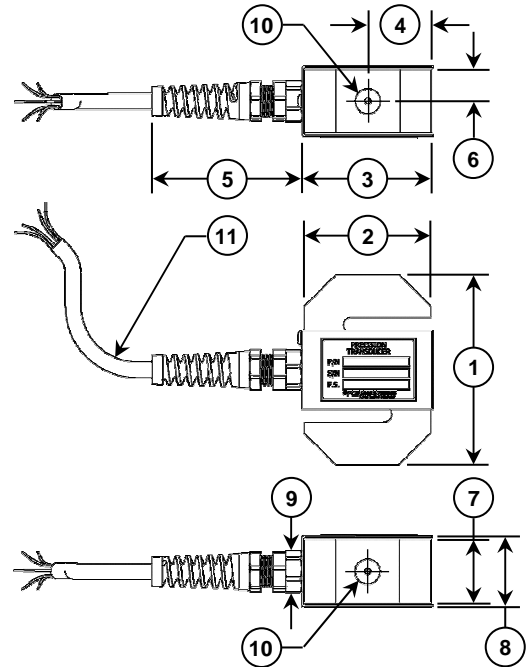

Figure 2 - Dimensions

Table 2 - Dimension Values

Dimensions (see Figure 2)	Series Number					
	1630		1631		1631-06C	
	(in)	(mm)	(in)	(in)	(in)	(mm)
1	2.50	63.5	3.00	76.2	3.50	88.9
2	2.00	50.8	2.00	50.8	2.50	63.5
3	2.05	52.1	2.05	52.1	2.55	64.8
4	1.00	25.4	1.00	25.4	1.25	31.8
5	2.00	50.8	2.00	50.8	2.00	50.8
6	0.31	7.9	0.50	12.7	0.75	19.1
7	0.63	15.9	1.00	25.4	1.50	38.1
8	0.74	18.8	1.11	28.3	1.61	41.0
9	Ø0.65	Ø16.5	Ø0.65	Ø16.5	Ø0.65	Ø16.5
10	1/4"-28 Tapped		1/2"-20 Tapped		5/8"-18 Tapped	
11	10 ft integral cable					

NOTE: For metric units, reference the outline drawing at the end of this manual for dimension values.

4.0 MECHANICAL INSTALLATION

Loads applied to S-type load cells must be even and centered. Compensation linkages (e.g. rod end bearing, alignment couplers) are recommended to help minimize load misalignment. When installing fixtures, be sure to thread the fixture to the load cell, and not the load cell to the fixture. If alignment fixtures are not used, ensure loading surfaces are flat and parallel, with loads applied in-line with the sensor.

5.0 ELECTRICAL INSTALLATION

Table 4 - Electrical Connections

Electrical Connection:	Pig-tailed, 10 ft, integrated cable
-------------------------------	-------------------------------------

5.1 Electrical Drawing / Western Regional Std.

All load cells are wired following the Western Region Standard. All models utilize strain gages configured into a Wheatstone Bridge Circuit to produce the primary sensing element. The four-arm Wheatstone bridge configuration is shown below in Figure 3.

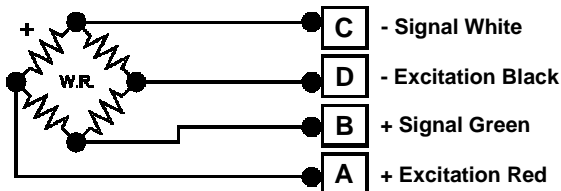

Figure 3 - Western Regional Strain Gage Committee Wiring Code

The gages are bonded to the load cell's structure. Typically, a regulated DC or AC excitation is applied between A and D of the bridge. When a force is applied to the load cell, the Wheatstone bridge becomes unbalanced, causing an output voltage between B and C, which is proportional to the applied load. This configuration allows for temperature and pressure compensation, as well as cancellation of signals caused by forces not directly applied to the axis of the applied load. Output is typically expressed in units of mV/V of excitation.

5.2 Output Polarity

The following figure describes the output polarity.

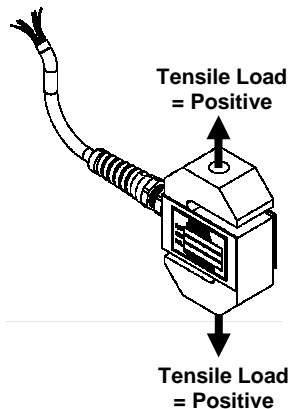

Figure 4 - Output Polarity

5.3 Cable & Grounding Considerations

Proper grounding and shielding is required to prevent electrical noise in strain gage load cell measuring systems. The cable must be shielded twisted pairs with a drain wire.

Cable shields must be grounded only at one end, for example, on the instrument or control system ground. The load cell case is grounded by mechanical attachment to the structure to which it is mounted.

The instrument or control system is grounded through its power cord. Ground loops and measuring system wiring may result in unstable or noisy signals.

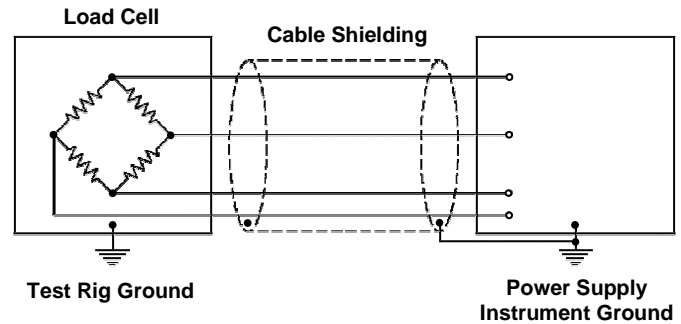

Figure 5 - Grounding

A simple test with a voltmeter connected between the power cord ground and the structure on which the load cell is mounted can confirm that the structure has been properly grounded. If the power cord ground and structure ground are not at the same potential, it may be necessary to provide a secure structure ground, perhaps by driving a copper rod and attaching a ground strap.

6.0 CALIBRATION

Every S-type load cell manufactured by PCB Load & Torque, Inc. has been fully calibrated per ISO/IEC 17025 procedures, and meets all published specifications. Each load cell will come with a calibration certificate designated with matching model and serial numbers. PCB Load & Torque also offers calibration services on an on-going basis.

6.1 Calibration Certificate Description

Calibration reports supplied with S-type load cells contain valuable information to assist the customer in use of the equipment. A separate calibration report is provided for tension and compression calibrations. Calibration procedures, equipment, and reports comply with ISO/IEC 17025.

6.1.1 Measured Output

The applied load starting at zero is measured in five increments to full scale. Output (mV/V) is measured at each increment. The straight-line from zero to the full scale measurement is compared to the measured readings at each increment to calculate the error at each load increment. The deviations (% Full Scale) corresponding to non-linearity at each measurement increment are then calculated.

6.1.2 Hysteresis

The difference between the ascending and descending measured readings at 40% of full scale is used to calculate the hysteresis value.

6.1.3 Best Fit Output

The best fit calibration second-order equation has been calculated from the calibration data by the method of least squares. Deviation between measured output and best-fit output is calculated and displayed in the column next to the best-fit output for each measurement increment. The deviations (% Full Scale) of measured outputs from the calculated best fit are tabulated for each measured reading.

6.1.4 Strain Gage Measurements

Table 5 – Strain Gage Measurements

Bridge Resistance:	350 Ohm Nominal
Excitation:	+P(A) to –P(D) Ohms
Signals:	+S(B) to –S(C) Ohms
Leakage to Ground:	> 5k GOhm
Bridge Unbalance:	±1.0% Full Scale
Output:	2.0 mV/V Nominal
Maximum Voltage:	20 VDC

6.1.5 Shunt Calibration Standard Resistor

All S-type load cell calibrations use a 60K Ohm (0.1%) precision resistor shunt calibration value that is supplied into the calibration report.

6.1.6 Static Error Band (SEB)

The static error band (SEB) is determined by the maximum deviations of the ascending and descending calibration points from the best fit straight line through zero output. The SEB includes the effects of nonlinearity, hysteresis, and non-return to minimum load.

7.0 SHUNT CALIBRATION DESCRIPTION

Shunt calibration is used to simulate a known tension or compression load on a load cell. The calibration certificate will indicate which leg of the bridge to apply the shunt resistor to for both tension and compression load simulation. Typically tension is simulated by inserting the shunt resistor between the +P and +S connector leads. Compression loading is simulated by inserting the shunt resistor between the +S and –P connector leads.

7.1 Resistor Value

S-type load cells have a nominal 2.0 mV/V full scale output. For a 350 ohm strain gage bridge the precision shunt resistor is, 60,000 ohms ± 0.1%, simulates an output of approximately 73% of the full scale output for the load cell. The calibration values for each bridge are found on the calibration certificates supplied with each load cell.

7.2 Shunt Calibration Process

To perform the shunt calibration, use the following procedure:

1. Stabilize all forces on the load cell. If possible, remove all loads.
2. Allow the powered sensor and signal conditioner to warm up for a minimum of 30 minutes
3. Set the load indicator display to read exactly 00.000.
4. Connect the shunt resistor to the terminals specified in the calibration certificate, and adjust the span or gain until the display reads the force value stated on the certificate.
5. Repeat steps 1-3 to verify that a valid calibration setting has been obtained.
6. If possible, apply a known load to the measurement system to further verify that the calibration has been accurately set up.

7.3 Estimating Shunt Resistor for a Given Load

The following formula can be used to estimate the approximate value of shunt resistor required to simulate a mechanical load.

$$R_{cal} = (250 * R_b) / (Output_{FS} * L_{cal})$$

Where:

R_{cal} = Shunt Resistor (K ohms)

R_b = Bridge Resistance (ohms)

$Output_{FS}$ = Full Scale output of the load cell (mV/V)

L_{cal} = Load to be simulated, % of Load Cell Capacity

8.0 MAINTENANCE

Routine maintenance of the S-type load cell should include cleaning the electrical connectors, housings, and mounting surfaces with solutions and techniques that will not harm the physical material of construction. Make sure liquids are not allowed to migrate into devices that are not hermetically sealed. Such devices should only be wiped with a damp cloth, and never be submerged or have liquids poured on them. Never use a pressure washer on the load cells.

Yearly calibrations are recommended to ensure that the unit's outputs match the factory specifications.

9.0 TROUBLE SHOOTING

Proper performance of a load cell requires careful attention to both electrical and mechanical aspects of the measurement system. A basic understanding of the electrical and mechanical installation requirements is recommended.

9.1 Mechanical Trouble Shooting

A mechanical checklist includes:

1. Check for proper installation of fixturing.
2. Check integrity of the fixturing.

9.2 Electrical Trouble Shooting

An electrical checklist should start with:

1. Check cables for proper wiring and make sure connections are secure and proper.
2. Inspect for loose or dirty electrical connections.
3. Check for improper shield grounds.
4. Check for proper grounding of the structure that the load cell is mounted on.
5. Check the signal conditioning electronics for proper setup.
6. Check the insulation resistance of shielded conductors for short circuits.
7. Check isolation resistance, load cell flexure to conductors.
8. Check load cell bridge resistances, (A-D) excitation and (B-C) the signal leads.
9. Check bridge balance.
10. Keep a record of your observations, correct problems, or contact PCB factory for assistance.

10.0 CALIBRATION / REPAIR SERVICES

PCB Load & Torque offers calibration and repair services. The PCB Calibration Laboratory in Farmington Hills, Michigan is A2LA Accredited per ISO/IEC 17025.

Standard calibration certificates list five force points ascending and one point descending. Additional data points are available at extra cost upon request. A 60 K ohm ($\pm 0.1\%$) shunt calibration resistor is supplied with each load cell calibration.

Certificate information includes tabulated measurement variable data zero balance, bridge input/output resistance, computer nonlinearity and hysteresis, static error band (SEB) calculations and entries abilities and traceability statements.

If an initial evaluation shows that a transducer requires repair, PCB will provide the customer with an estimate prior to taking any corrective action.

10.1 RMA / Purchase Order

Please request a return material authorization (RMA) before sending a load cell back to the factory for any reason. For calibration services, if possible, a copy of the purchase order covering the requested services should be included with the returned load cell.

11.0 WARRANTY

Standard warranty on S-type load cells covers parts and workmanship. For full details, refer to the Warranty Statement supplied with each load cell.

If the load cell is defective for reasons other than overloads, return it to the factory for detailed evaluation. Factory evaluation may show that the load cell is repairable or non-repairable and if repair or replacement will be under warranty. If not under warranty, the customer will be contacted with the cost of repairs and recalibration. Once authorization to proceed is received, a delivery date will be provided.

*Manual Number: 55947
Manual Revision: A
Revision Date: 6/25/19
ECO Number: 49636*

Model Number 1631-03C		STRAIN GAGE LOAD CELL		Revision: D ECN #: 43825
Performance	ENGLISH	SI		OPTIONAL VERSIONS
Measurement Range	1000 lb	4448 N	[5]	Optional versions have identical specifications and accessories as listed for the standard model except where noted below. More than one option may be used.
Sensitivity(± 10 %)	2 mV/V	2 mV/V	[6]	
Non-Linearity	≤ 0.05 % FS	≤ 0.05 % FS		
Hysteresis	≤ 0.03 % FS	≤ 0.03 % FS		
Non-Repeatability	≤ 0.02 %RO	≤ 0.02 %RO		
Resonant Frequency	3.2 kHz	3.2 kHz		
Creep(in 20 minutes)	≤ 0.08 %	≤ 0.08 %		
Environmental				NOTES:
Overload Limit	1500 lb	6672 N		[1]Nominal.
Load Limit(Side Force, F _X or F _Y)	100 lb	445 N	[3]	[2]Calibrated at 10 VDC, usable 5 to 20 VDC or VAC RMS.
Load Limit(Bending Moment, M _X or M _Y)	200 in-lb	22.6 Nm	[3]	[3]Singularly applied, i.e. no other extraneous loads.
Load Limit(Axial Torque, M _Z)	200 in-lb	22.6 Nm	[3]	[4]Over compensated operating temperature range.
Temperature Range(Operating)	0 to +200 °F	-18 to +93 °C		[5]FS - Full Scale.
Temperature Range(Compensated)	+70 to +170 °F	+21 to +77 °C		[6]RO - Rated Output.
Temperature Effect on Output(Maximum)	± 0.0005 %Reading/°F	± 0.0015 %Reading/°C	[4]	[7]See Outline Drawing 46138 for Complete Dimensions
Temperature Effect on Zero Balance(Maximum)	± 0.0015 %FS/°F	± 0.027 %FS/°C	[4]	
Electrical				
Bridge Resistance	350 Ohm	350 Ohm	[1]	Entered: AP
Excitation Voltage(Recommended)	10 VDC	10 VDC	[2]	Engineer: PE
Insulation Resistance	>5x10 ⁹ Ohm	>5x10 ⁹ Ohm		Sales: JC
Zero Balance	± 1 % FS	± 1 % FS		Approved: JSD
Output Polarity	+Tension	+Tension		Spec Number:
Physical				Date: 2/16/2015
Size (Length x Height x Width)	2.0 in x 3.0 in x 1.0 in	51.0 mm x 76.2 mm x 25.4 mm	[7]	Date: 2/16/2015
Weight	0.43 lb	195 g		Date: 2/16/2015
Mounting Thread	1/2-20 Thread	No Metric Equivalent		45998
Housing Material	Aluminum	Aluminum		
Sensing Element	Strain Gage	Strain Gage		
Deflection at Full Scale Capacity	0.0025 in	0.05 mm		
Electrical Connector	10 ft - Integrated Cable	10 ft - Integrated Cable		
Electrical Connection Position	Side	Side		
<p><i>All specifications are at room temperature unless otherwise specified. In the interest of constant product improvement, we reserve the right to change specifications without notice.</i></p>				
			<p>PCB Load & Torque, Inc. 24350 Indoplex Circle Farmington Hills, MI 48335 UNITED STATES Phone: 866-684-7107 Fax: 716-684-0987 E-Mail: ltinfo@pcbloadtorque.com Web site: http://www.pcbloadtorque.com</p>	



2

1

PCB Load & Torque Inc. claims proprietary rights in the information disclosed hereon. Neither it nor any reproduction thereof will be disclosed to others without the written consent of PCB Load and Torque Inc.

REVISIONS

REV	DESCRIPTION	ECO
A	ADDED NOTE - 12.10.24, PTE	55424

46138



4 CONDUCTOR BLACK SHIELDED CABLE 10.0 FT [3.0 M] LONG TERMINATING IN PIGTAILS (WESTERN REGIONAL WIRING)

STRAIN RELIEF

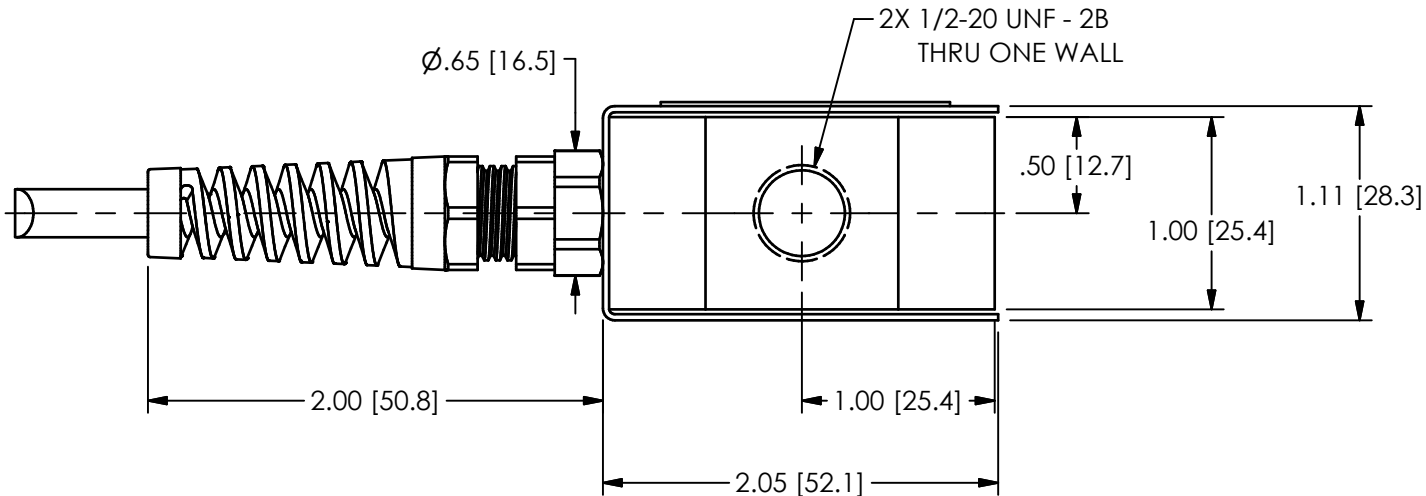
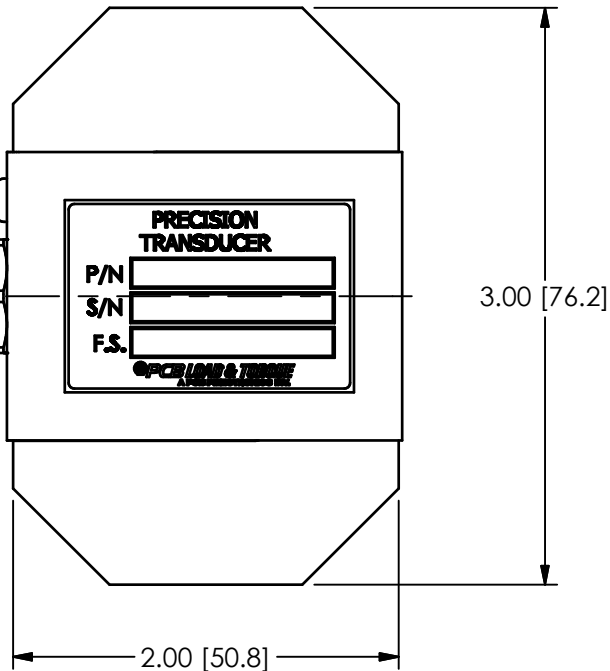

OPTIONAL CABLE TERMINATIONS AVAILABLE

UNLESS OTHERWISE SPECIFIED TOLERANCES ARE:

DIMENSIONS IN INCHES	DIMENSIONS IN MILLIMETERS [IN BRACKETS]
DECIMALS XX ±.01 XXX ±.005	DECIMALS X ±0.3 XX ±0.13
ANGLES ± .5 DEGREES	ANGLES ± .5 DEGREES
FILLETS AND RADII .015 MAX	FILLETS AND RADII 0.38 MAX

DRAWN		CHECKED		ENGINEER	
SMB	06.27.11	JM	06.27.11	JAM	6/27/11

TITLE
OUTLINE DRAWING
MODEL 1631 SERIES
S-CELL



24350 Indoplex Circle, Farmington Hills, MI 48335
(716) 684-0001 E-MAIL: linfo@pcbloadtorque.com

DWG. NO.
46138

SCALE: FULL SHEET 1 OF 1

2

1